



CE

319V21EN

CONTROL PANEL
FOR 24 V GEARMOTORS



INSTALLATION MANUAL
ZL92



English

EN



WARNING!

Important instructions for the safety of people: READ CAREFULLY!



Foreword

• Use of the products must be restricted to its intended use (i.e. that for which it was expressly built for). Any other use is to be considered dangerous. Came Cancelli Automatici S.p.A. is not liable for any damage resulting from improper, wrongful or unreasonable use • Keep these warnings with the installation and use manuals issued with the automated system.

Before installing

(preliminary check: in case of a negative outcome, do not proceed before having complied with the safety obligations)

• Make sure that the parts you intend to automate are in good working order, and that they are properly balanced and aligned. Also, make sure that proper mechanical stops are already in place • If the operator will be installed at a height of less than 2.5 m from the ground or other access level, check whether you will need any protections and/or warnings • Any gate leaves, fitted with pedestrian entrances, onto which you will install an operator, must have a blocking mechanism when the gate is in motion • Make sure that the opening of the automated gate is not an entrapment hazard as regards any surrounding fixed parts • Do not mount the operator upside down or onto any elements that may fold under its weight. If needed, add suitable reinforcements at the points where it is secured • Do not install onto gates on either an upward or downward slope (i.e. that are not on flat, level ground) • Check that any lawn watering devices will not wet the gearmotor from the bottom up.

Installation

• Carefully section off the entire site to prevent unauthorised access, especially by minors and children • Be careful when handling operators that weigh more than 20 Kg (see installation manual). In such cases, employ proper weight handling safety equipment • All opening commands (e.g. buttons, key selectors, magnetic detectors, etc.) must be installed at least 1.85 m from the gate's area of operation perimeter - or where they cannot be reached from the outside of the gate. Also, the direct commands (e.g. push button, or proximity devices, etc.) must be installed at a height of at least 1.5 m and must not be accessible to the public • All 'maintained action' commands, must be placed where the moving gate leaves, transit areas and driveways are completely visible • If missing, apply a permanent label that shows the position of the release mechanism • Before delivering to the client, verify that the system is EN 12453 (impact test) standard compliant. Make sure that the operator has been properly adjusted and that the safety and protection devices, as well as the manual release

are working properly • Where necessary and in plain sight, apply the Warning Signs (e.g. gate plate).



Special instructions and advice for users

• Keep the gate's area of operation clean and clear of any obstacles. Trim any vegetation that may interfere with the photocells • Do not allow children to play with the fixed command devices, or in the gate's area of operation. Keep any remote control devices (i.e. transmitters) away from the children as well • Frequently check the system, to see whether any anomalies or signs of wear and tear appear on the moving parts, on the component parts, on the securing points, on the cables and any accessible connections. Keep any joints (i.e. hinges) lubricated and clean, and do the same where friction may occur (i.e. slide rails) • Perform functional tests on photocells and sensitive edges, every six months. Keep glass panels constantly clean (use a slightly water-moistened cloth; do not use solvents or any other chemical products) • If the system requires repairs or modifications, release the operator and do not use it until safety conditions have been restored • Cut off the power supply before releasing the operator for manual openings. See instructions • Users are FORBIDDEN to carry out ANY ACTIONS THAT THEY HAVE NOT BEEN EXPRESSLY ASKED TO DO OR SO INDICATED in the manuals. Any repairs, modifications to the settings and extraordinary maintenance MUST BE DONE BY THE TECHNICAL ASSISTANCE STAFF • On the periodic maintenance log, note down the checks you have done.

Special instructions and advice for all

• Avoid working near the hinges or moving mechanical parts • Stay clear of the gate's area of operation when in motion • Do not resist the direction of movement of the gate; this may present a safety hazard • At all times be extremely careful about dangerous points that must be indicated by proper pictograms and/or black and yellow stripes • When using a selector or command in 'maintained action' mode, keep checking that there are no people in the area of operation of the moving parts. Do this until you release the command • The gate may move at any time without warning • Always cut the power when cleaning performing maintenance.

Legend of symbols

-  This symbol shows which parts need to be read carefully.
-  This symbol shows which parts have to do with safety.
-  This symbol shows what to tell end users.

Intended use and limitations of use

Intended use

The ZL92 control panel is engineered to command 24 V DC operators for swing gates of the STYLO, MYTO, FROG-J and AMICO series.

 Any installation and use other than that explained in this manual are forbidden.

Limitations to use

Follow all cable distance and diameter instructions as shown in the table "Cable type and section"

The overall power of the motors must not exceed 300 W.

Description

Engineered and manufactured entirely by CAME Cancelli Automatici S.p.A..

The control panel is powered by 230 V AC, with 50 / 60 Hz frequency. The command devices and accessories work on 24 V. Warning! The accessories must not exceed 50 W overall.

The transformers are fitted with a protection that keep the gate leafs open even when overheating. The leafs are closed only after the temperature falls below overheating threshold.

All connections are protected by quick fuses, see table.

Functions on the input and output contacts, time adjustments and user management, are all handled via the display and managed by the software.

It is set up to fit the LB90 card which provides power to the electrical board via emergency batteries, which are in turn automatically triggered during power outages. When the line current returns, it recharges the batteries.

Technical data

TECHNICAL DATA	
Power supply	230 V - 50/60 Hz
Maximum rated power	300 W
Power draw when idle	110 mA
Maximum power for 24 V accessories	50 W
Insulation class of the circuits	II
Container material	ABS
Container protection rating	IP54
Working temperature	-20 / +55°C

FUSE TABLE	
to protect:	fuse rated to:
Electronic line card	3.15 A-F = 120 V 1.6 A-F = 230 V
24 V accessories	2°-F
Command device (control panel)	1 A-F
Motor 1 / Motor2	6.3 A =250 V Ø6,3x22 UFG632310
Replacement code (fuse)	119RIR316

Dimensions

(mm)

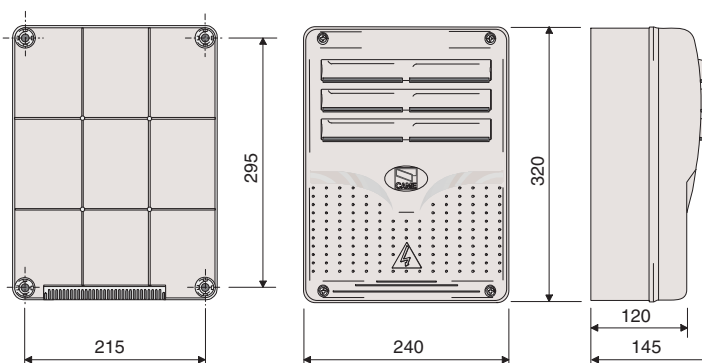

Main component parts

- 1 -Transformer
- 2 -Card fuse
- 3 -Accessories fuse
- 4 -Display
- 5 -Memory roll card connector
- 6 -AF card connector
- 7 -R700 or R800 card connector
- 8 -Lack of calibration warning LED indicator
- 9 -Programming buttons
- 10 -Terminal boards
- 11 -230 V power terminal boards
- 12 -Line fuse
- 13 -Current on-line warning LED indicator
- 14 -Motor 1 fuse
- 15 -Motor 2 fuse
- 16 -Antenna connection terminal board
- 17 -Thermal terminal board

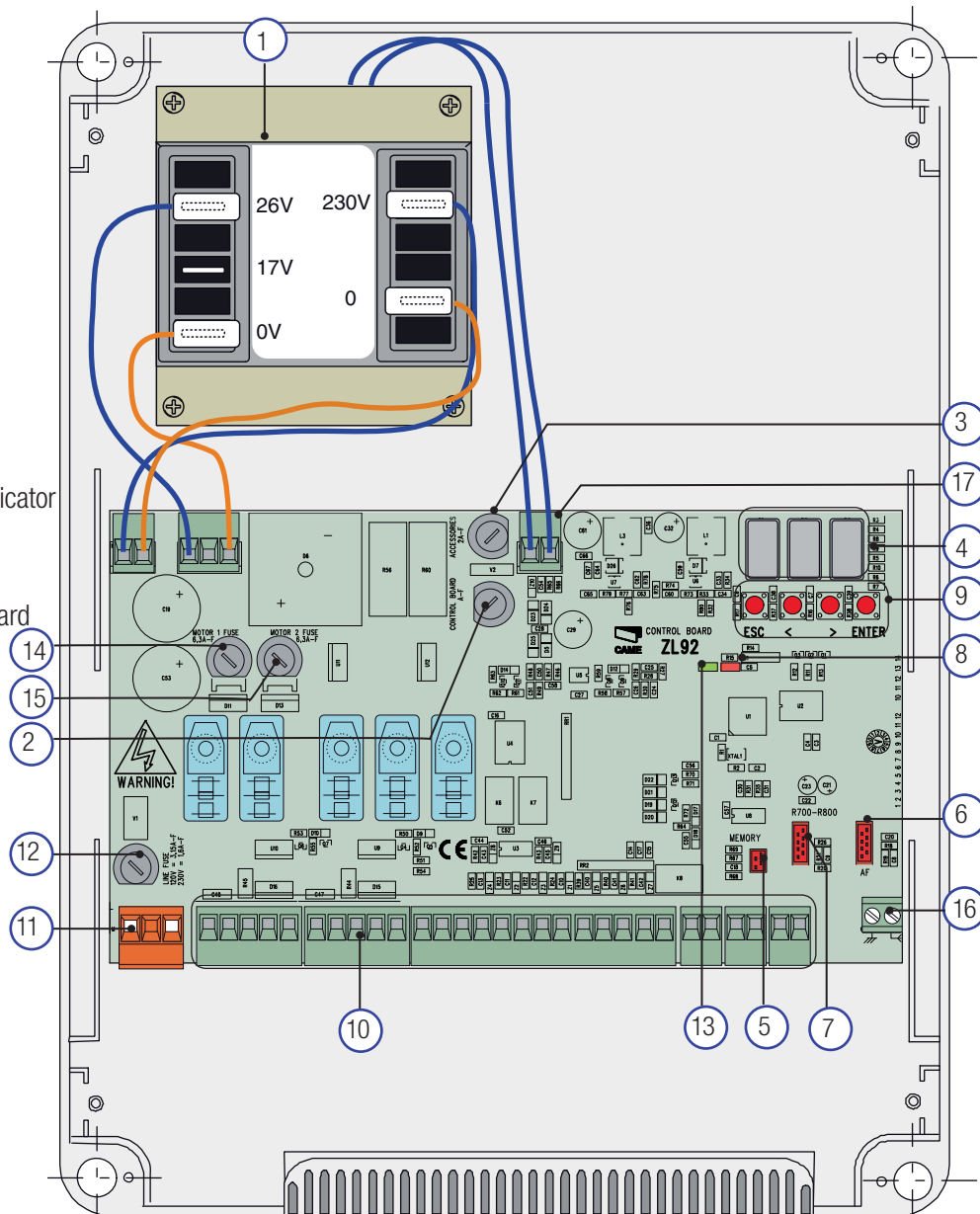

⚠ Warning! Before doing any work on the control panel, make sure to cut off the main current or disconnect the batteries.

Installation

⚠ Installation must be done by qualified, expert staff and in full compliance with current laws and regulations.

Preliminary checks

⚠ Before installing, do the following:

- Check that the control panel is anchored to a solid surface which is protected from possible impacts, and that the nuts, bolts, wall plugs, etc., are suitable for the job.
- Make sure you have a suitable omnipolar cut-off device with contacts more than 3 mm apart, and independent (sectioned off) power supply.
-  Make sure that any connections inside the box (that provide continuance to the protective circuit) are fitted with extra insulation as compared to the other conductive parts inside.
- Set up proper pipes and conduits for electrical cables to pass through, making sure these are protected from mechanical damage.

Tools and equipment

Make sure you have all of the tools and materials you will need to proceed with the installation in total safety, according to current rules and regulations.

Here are some examples.



Anchoring and mounting the box

1) Secure the base of the panel to a protected area; we suggest using cross slot Phillips head bolts of max. 6 mm in diameter.

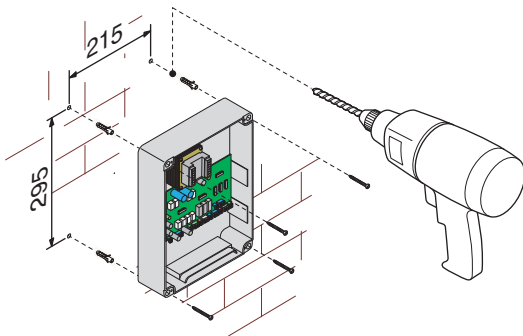

2) Perforate the pre-punched holes and insert the cable glands with the corrugated tubing for the electrical cables to travel through.

N.B.: diameter of the pre-punched holes: 20 mm.

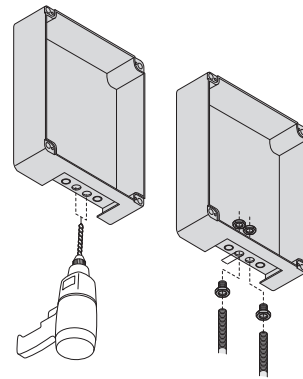

3) Assemble the pressure hinges.

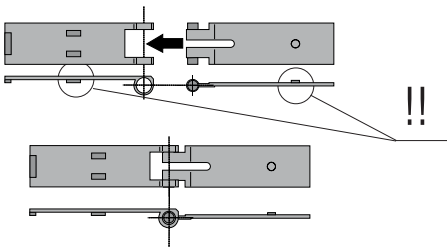

4) Insert the hinges into the box (either on the right or left side, as you prefer) and secure them using the supplied nuts and bolts.

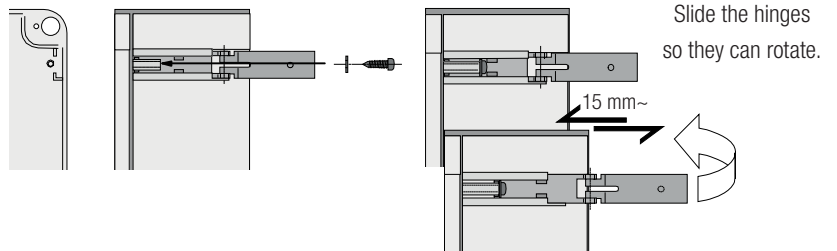

5) Snap the hinge covers into place.

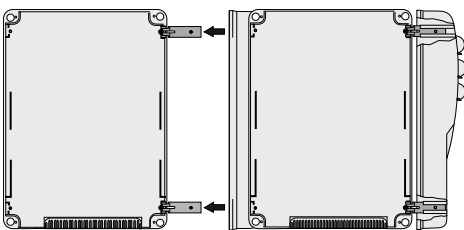

6) After any calibrations and adjustments, secure the cover using the supplied screws.

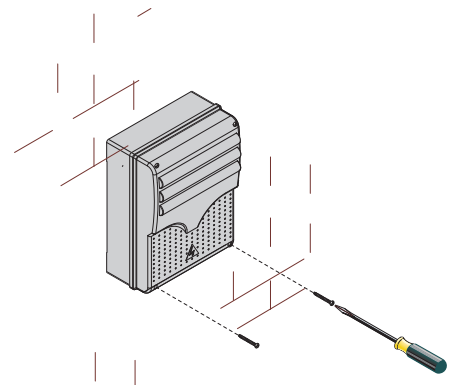

Electrical connections

Cable types and sections

Connections	Type of cable	Length of cable 1 < 10 m	Length of cable 10 < 20 m	Length of cable 20 < 30 m
Control panel power supply	FROR CEI 20-22 CEI EN 50267-2-1	3G x 1,5 mm ²	3G x 1,5 mm ²	3G x 2,5 mm ²
Power supply to motor* with encoder		3G x 1,5 mm ²	3G x 1,5 mm ²	3G x 2,5 mm ²
Power supply to motor** with encoder		4G x 1,5 mm ²	4G x 1,5 mm ²	4G x 2,5 mm ²
Flashing light		2 x 1,5 mm ²	2 x 1,5 mm ²	2 x 1,5 mm ²
Photocell transmitters		2 x 0,5 mm ²	2 x 0,5 mm ²	2 x 0,5 mm ²
Photocell receivers		4 x 0,5 mm ²	4 x 0,5 mm ²	4 x 0,5 mm ²
Power supply to accessories		2 x 0,5 mm ²	2 x 0,5 mm ²	2 x 1 mm ²
Command and safety devices	2 x 0,5 mm ²	2 x 0,5 mm ²	2 x 0,5 mm ²	
Antenna connection	RG58	Maximum 10 m		

* MYTO ME - FROG J - AMICO - STYLO RME / ** STYLO ME

N.B.: If the cable length differs from that specified in the table, then you must determine the proper cable diameter based on the actual power draw from the connected devices and according to the CEI EN 60204-1 standards.

For connections that require several, sequential loads, the sizes given on the table must be re-evaluated based on actual power draw and distances.

When connecting products that are not specified in this manual, please follow the documentation provided with said products.

Power source and accessories

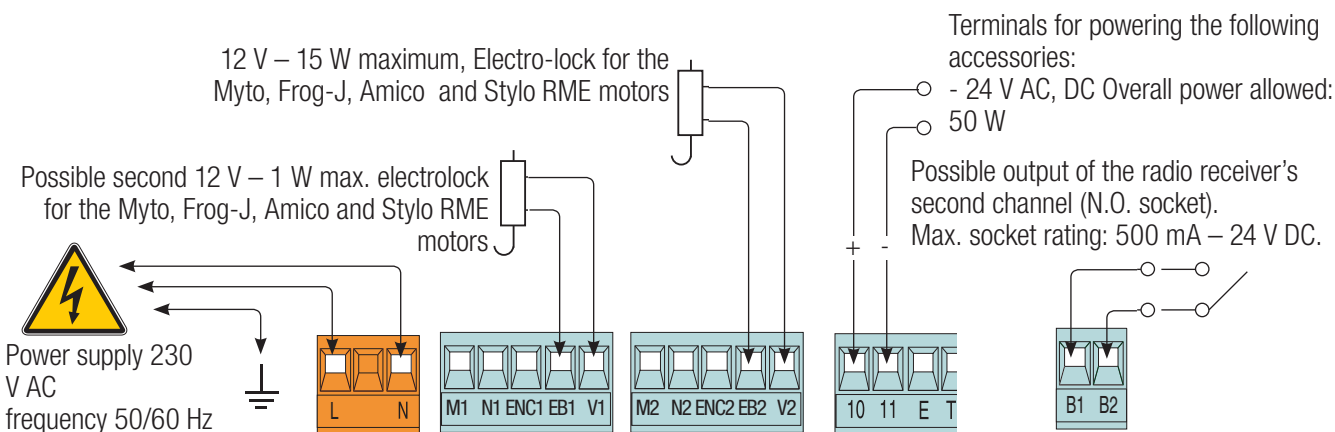

Gearmotor

M1 – 24 V DC gearmotor featuring delayed action on opening

M2 - 24V DC gearmotor featuring delayed action on closing

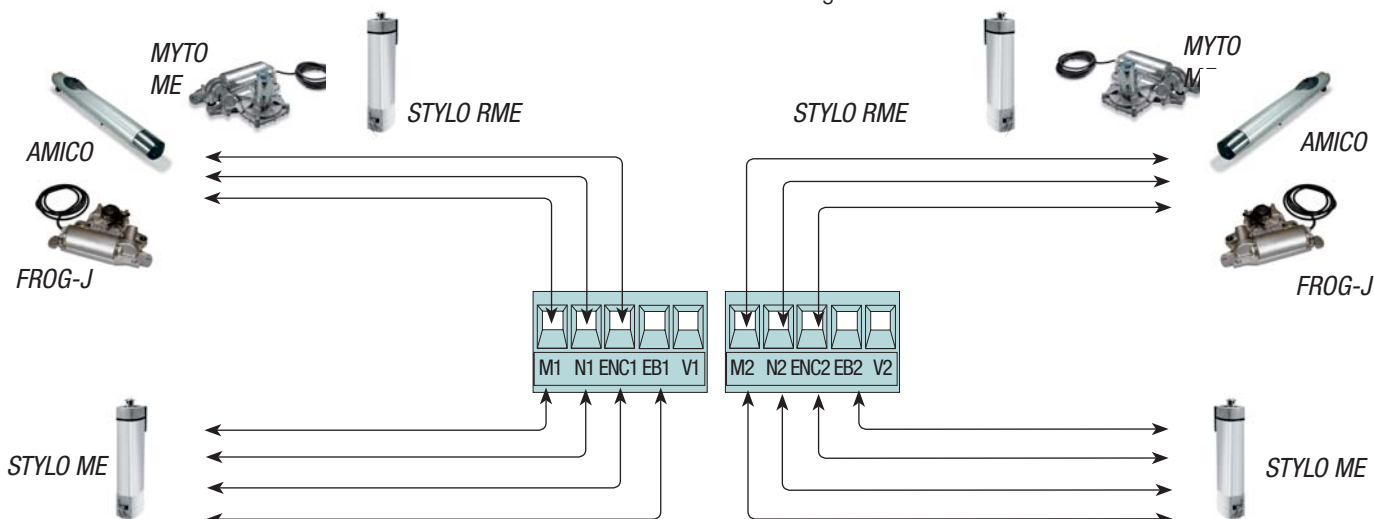

P. 7 - Manual code: 319V21EN Vers. 3 09/2014 © CAME cancelli automatici S.p.A. - The data and information in this manual are subject to change at any time without prior notice required by CAME Cancelli Automatici S.p.A.

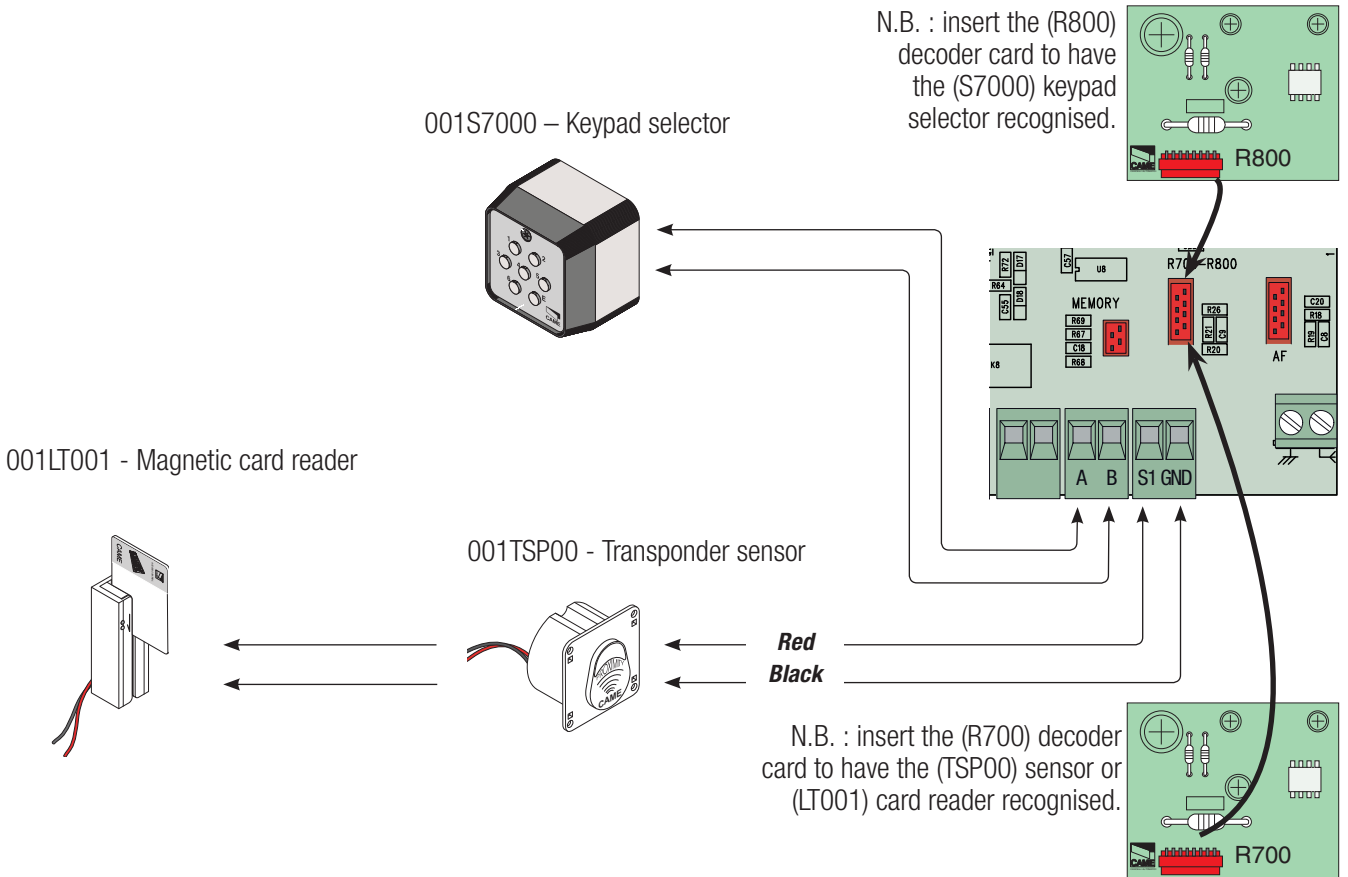

Stop button (N.C. contact) - Button to stop gate while excluding the automatic closing cycle. For movement to resume you must press the command button or transmitter button.
N.B.: if the contact is unused, select "0" = (Disabled) from the F1 functions menu.

Key selector and/or opening button (N.O. contact) - Gate opening command.

Key selector and/or partial opening button (N.O. contact) - Partial gate opening for pedestrian access.

Key selector and/or closing button (N.O. contact) - Gate closing command.

Key selector and/or commands button (N.O. contact) - Commands for opening and closing the gate – pressing the button or turning the key-switch, inverts the gate's movement or stops it depending on how it is set on the 2-7 command in the "FUNCTIONS" menu.

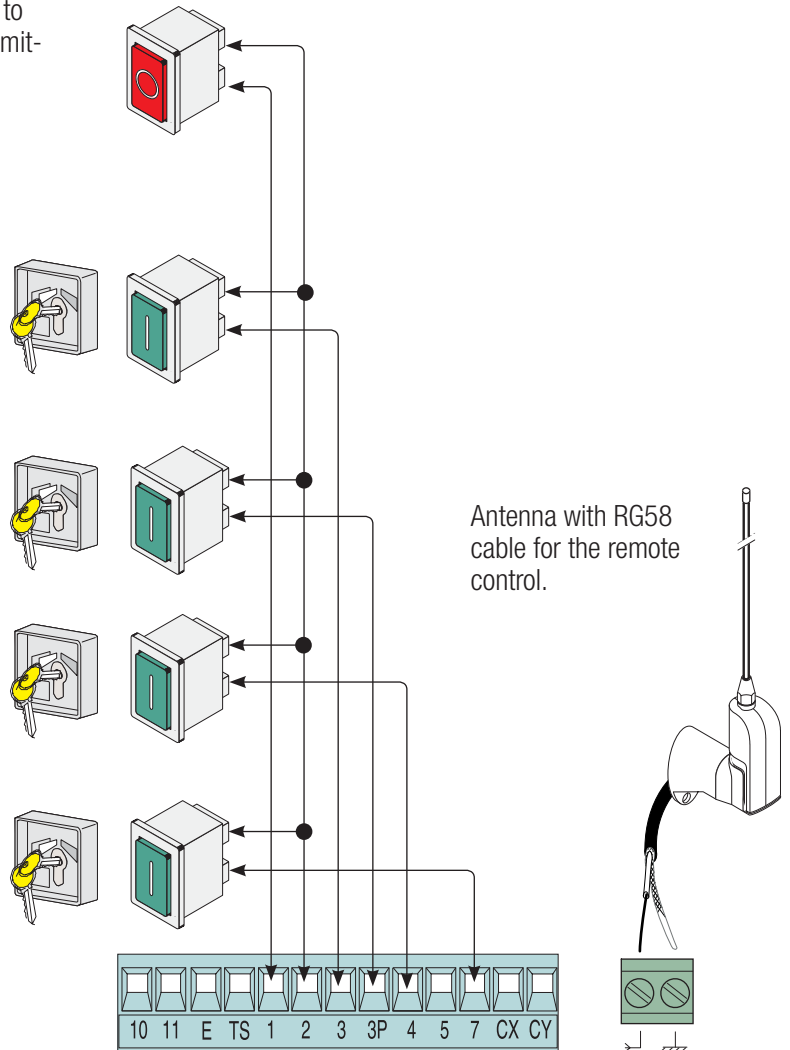

Warning devices

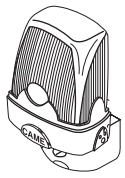

Flashing light (socket rating: 24 V DC - 25 W max.) – It flashes during opening and closing phases of leaf.



Courtesy or cycle light (contact rated up to: 24V – 25 W max.) – auxiliary connection of an outdoor lamp that can be freely positioned, for additional lighting of the driveway.
 Cycle light: It stays on from the moment the gate begins opening until it is fully closed (including the automatic closing time).
 Courtesy light: Stays on for a fixed time period (see function “F25”).

Open gate indicator-light (Socket rating: 24 V – 3 W max.). It turns on when the gate is open. It turns off when the gate is closed (see function “F10”).

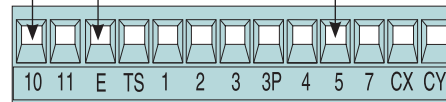
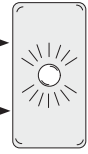

Safety devices

Configure either (N.C.) contacts CX or CY , input for EN 12978 compliant safety devices such as photocells. See CX (F2 Function) or CY(F3 Function) input functions in:

- C1 «re-open during closing phase», when the gate leaf is closing, opening the contact triggers the inversion of the direction of movement until the gate leaf is fully open.

- C2 «re-close during opening phase», when the gate leaf is opening, if the contact is opened it triggers an inversion of the direction until gate leaf is fully closed;

- C3 «partial stop», halts moving gate leaves and causes them to automatically close (if this functions has been selected);

- C4 «stand-by obstacle», stops the moving gate leaves causing them to start moving again once obstacle is removed.

N.B. : if CX and CY contacts are unused they need to be deactivated during programming.

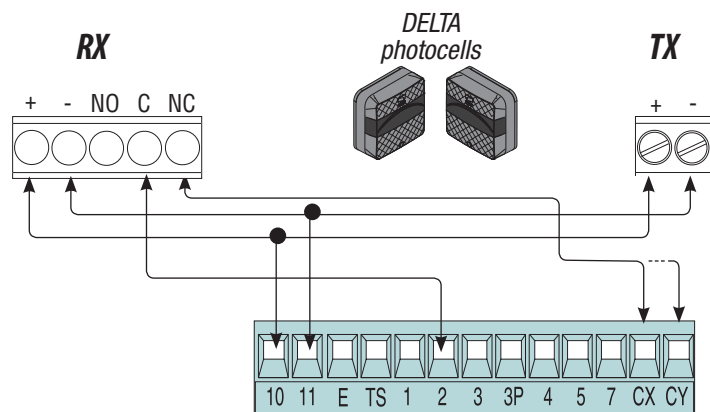
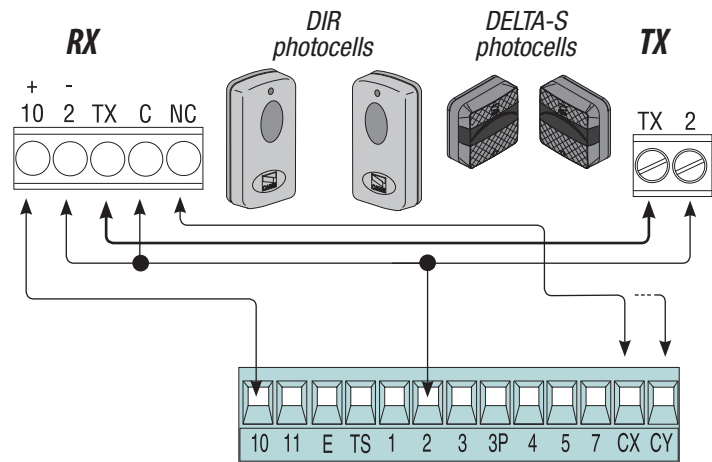

Configure either (N.C.) contacts CX or CY, input for safety devices such as sensate edges, that comply with EN 12978 standards. See CX (F2 Function) or CY(F3 Function) input functions in:

- C7 «re-open while closing», during gate closing, opening the contact causes inversion of movement until gate is fully open;
- C8 «re-close while opening», during gate opening, opening the contact causes inversion of movement until gate is fully close.

N.B. : if CX and CY contacts are unused they need to be deactivated during programming.

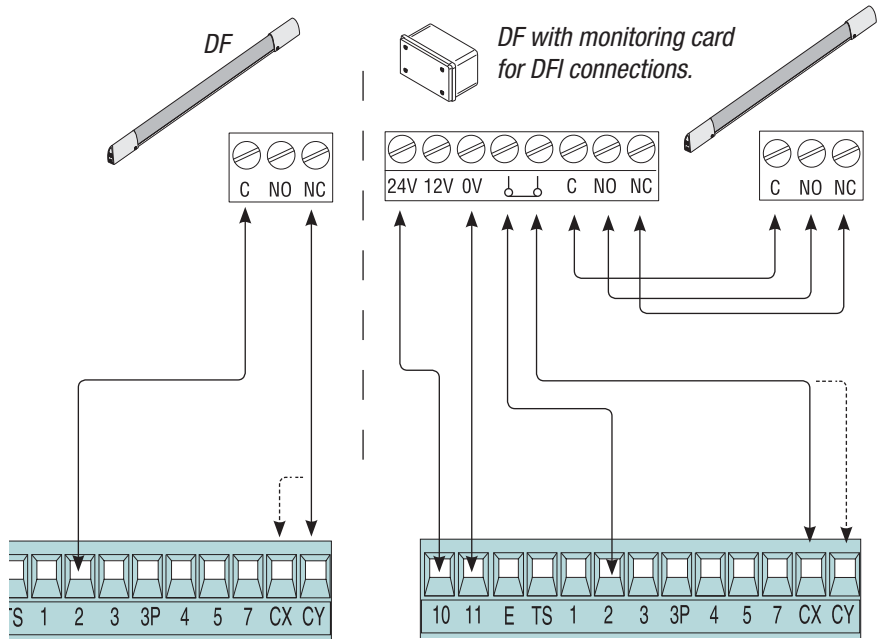

Electrical connection for running the photocells safety test

DOC / DELTA

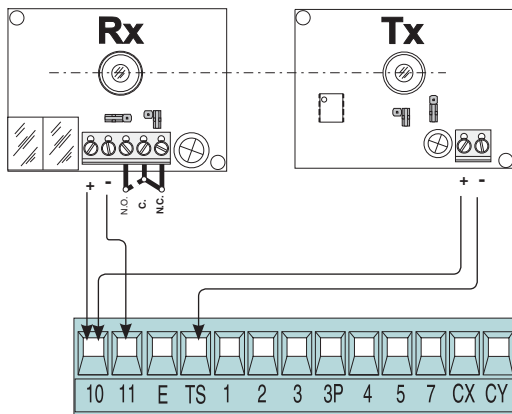

DIR / DELTA S

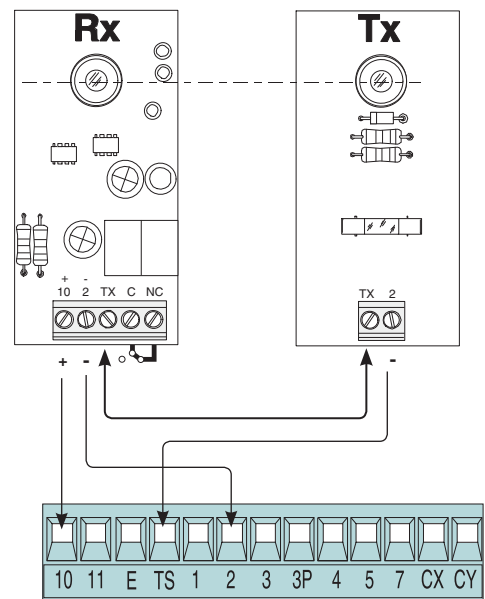

At each opening and closing command, the control board assesses the efficiency status of the safety devices (photocells). Any anomaly found is signaled with the flashing of the LED on the control board. Consequently it cancels any commands coming from the transmitter or the button.

Electrical connection to enable the photocell safety test:

- the transmitter and the receiver, must be connected as per the diagram;
- from the "F5" function select which inputs to run the safety test on.

Description of commands

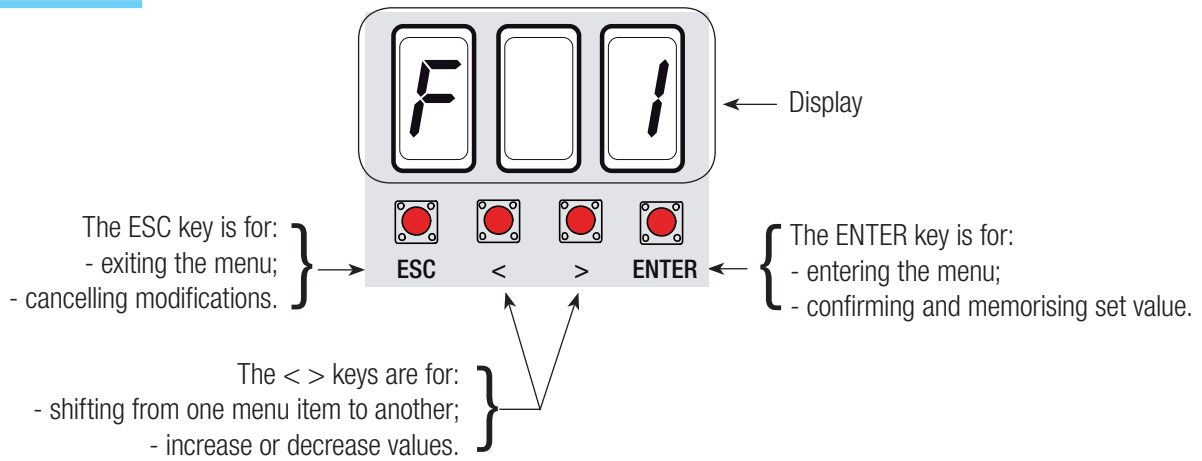

Navigazione menu

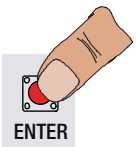

To enter the menu, keep the ENTER key pressed for at least one second.

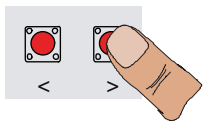
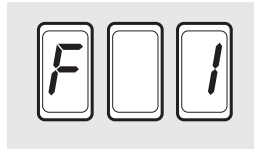

To increase or reduce values, use the greater than-less than keys...

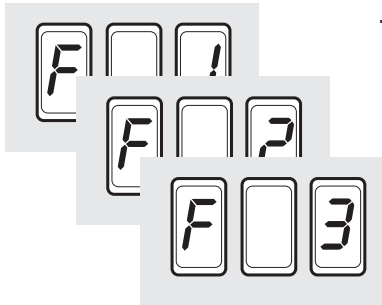

...then press ENTER

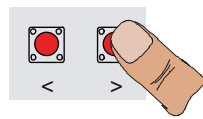
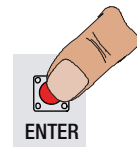

Even for the "sub-menus", use the greater than-less than arrows...

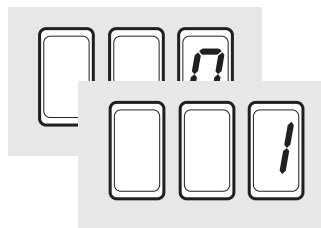

...then press ENTER

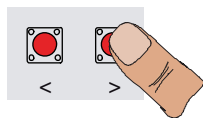
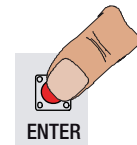

To increase or reduce values, use the greater than-less than keys...

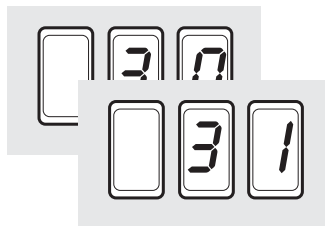

...then press ENTER to confirm...

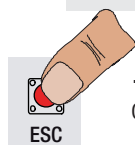
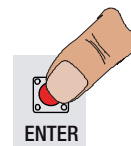

...to exit the menu, wait 10 seconds, or press ESC..



N.B.: when the menu is active, the system cannot be used.

- F 1 – “Total stop” Function
- F 2 – function assigned to CX input
- F 3 – function assigned to CY input
- F 5 – Safety test function
- F 6 – maintained action function
- F 7 – Command mode on 2-7
- F 8 – Command mode on 2-3p
- F 9 – Obstacle detection function when motor is stopped
- F 10 – Warning light function
- F 11 – Exclude Encoder function
- F 12 – Slow start function
- F 13 – Closing thrust function
- F 14 – Sensor type selector function
- F 16 – Ram head blow function (only for Myto – Amico – Frog J - Stylo RME motors)
- F 17 – Lock function (only for Myto – Amico – Frog J - Stylo RME motors)
- F 18 – Supplementary light function
- F 19 – Automatic closing time
- F 20 – Automatic closing time after partial opening
- F 21 – pre-flashing time
- F 22 – Working time
- F 23 – Delay opening time
- F 24 – Delay closing time
- F 25 – Courtesy light time
- F 26 – Ram head blow time (only for Myto – Amico – Frog J - Stylo RME motors)
- F 27 – lock time (only for Myto – Amico – Frog J - Stylo RME motors)
- F 28 – M1 motor speed adjustment
- F 29 – M2 motor speed adjustment
- F 30 – M1 motor speed slow-down time adjustment
- F 31 – M2 motor speed slow-down time adjustment
- F 32 – Additional closing slow down adjustment for M1 and M2 motors (only for Myto and Stylo with straight-arms)
- F 33 – Calibration speed adjustment
- F 34 – Sensitivity during movement
- F 35 – Sensitivity during slow-downs
- F 36 – Adjusting partial openings
- F 37 – Adjusting the initial slow-down point of the M1 motor when opening
- F 38 – Adjusting the initial slow-down point of the M1 motor when closing
- F 39 – Adjusting the point the M1 motor begins drawing to the fully open position
- F 40 – Adjusting the point the M1 motor begins drawing to the fully closed position
- F 41 – Adjusting the initial slow-down point of the M2 motor when opening
- F 42 – Adjusting the initial slow-down point of the M2 motor when closing
- F 43 – Adjusting the initial drawing to stop point of the M2 motor when opening
- F 44 – Adjusting the initial drawing to stop point of the M2 motor when closing
- F 45 – Adjusting an additional slow-down point when closing (only for Myto and Stylo RME with straight-arms)
- F 46 – Adjusting the number of motors
- F 50 – Saving data in memory roll
- F 51 – Reading memory roll data

- U 1 – Type of command to associate to a user via radio command
- U 2 – Cancelling single users
- U 3 – Cancelling all user

- A 1 – Setting the type of gearmotor
- A 2 – Motor tests
- A 3 – Gate run calibration
- A 4 – Resetting parameters

- H 1 – Software version

IMPORTANT! Before setting adjusting any functions, set which gearmotors are installed in the system (A 1 – Motor type), check the gate’s proper direction of travel of (A 2 – Motors test) and calibrate the gate run (A 3 – Gate run calibration)

Note: press ENTER to confirm after choosing each function value.

Motors test and calibration menu

A 1 (Motor type): setting up the type of swing gate gearmotor installed.

1 = Stylo ME with jointed-arm; 2 = Stylo ME with straight arm; 3 = Myto; 4 = Frog-J; 5 = Amico; 6 = Stylo RME with jointed-arm; 7 = Stylo RME with straight arm

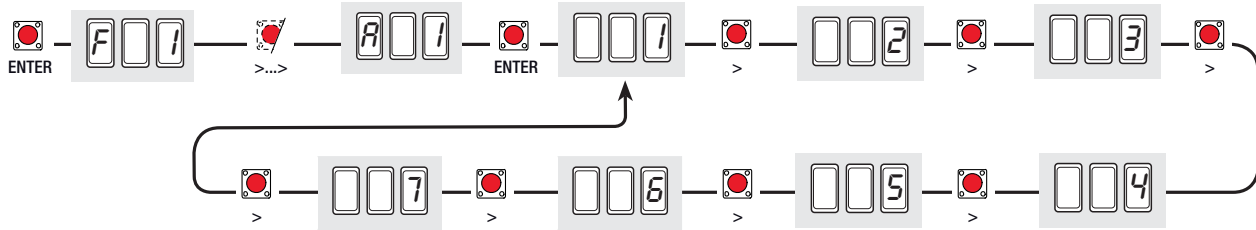

A 2 (motors test): activating the test to verify the proper turning direction of the gearmotors (see “motors test” paragraph).

0 = Deactivated; 1 = Activated.

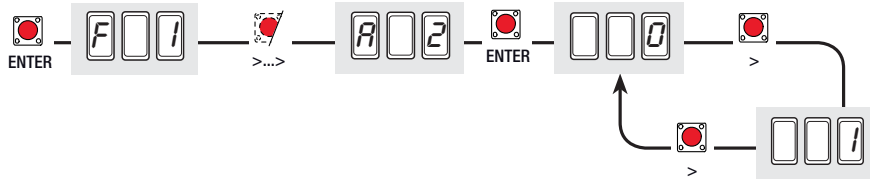

A 3 (Calibrating the gate run): automatic calibration of the gate run on both gearmotors (see “gate run calibration” paragraph).

0 = Deactivated; 1 = Activated

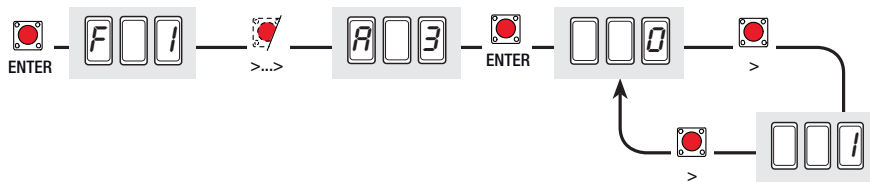

A 4 (Reset parameters): data resetting (default setting) and cancelling the gate run calibration.

0 = Deactivated; 1 = Activated.

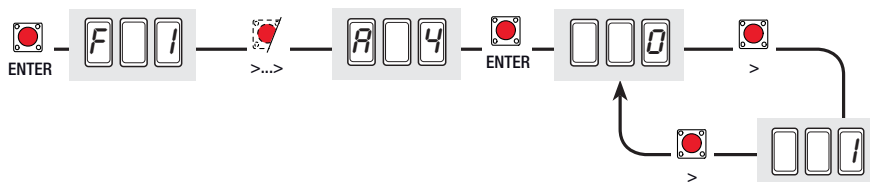

Functions menu

F1 (Total Stop): this function stops the gate and consequently excludes any automatic closing cycle; for movement to resume, you need to use the keypad or transmitter. Insert the safety device on [1 -2]; if unused, select "0" function.

0 = Deactivated; 1 = Activated (*default setting*)

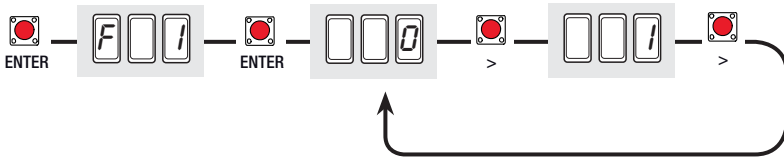

F2 (CX input): the N.C. safety contact input can take on the following functions: C1 (re-opening when closing), C2 (re-closing when opening), C3 (partial stop), C4 (obstacle stall), C7 (re-opening when closing, for sensitive edges), C8 (re-closing when opening, for sensitive edges) or, be deactivated. See safety devices on electrical connections.

0 = Deactivated (*default setting*); 1 = C1; 2 = C2; 3 = C3; 4 = C4; 7 = C7; 8 = C8.

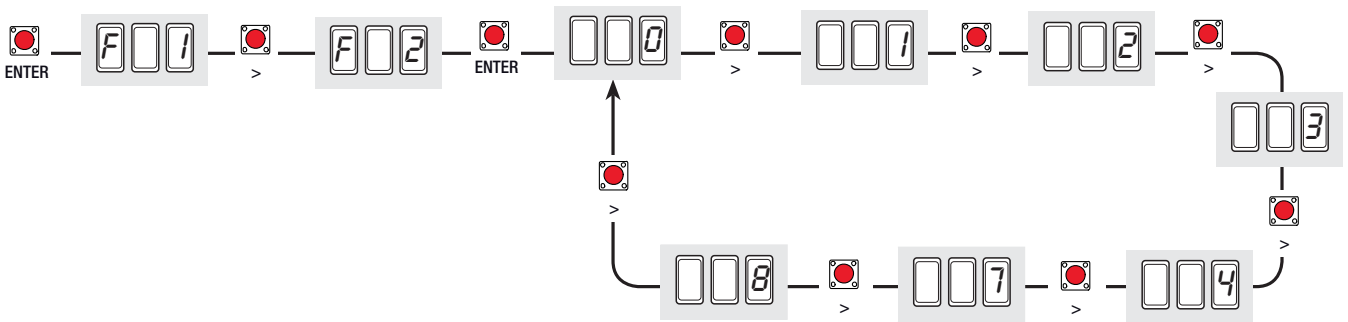

F3 (CY Input): safety contact input can take on the following functions: C1 (re-opening when closing), C2 (re-closing when opening), C3 (partial stop), C4 (obstacle stall), C7 (re-opening when closing, for sensitive edges), C8 (re-closing when opening, for sensitive edges) or, be deactivated.

See safety devices on electrical connections.

0 = Deactivated (*default setting*); 1 = C1; 2 = C2; 3 = C3; 4 = C4; 7 = C7; 8 = C8.

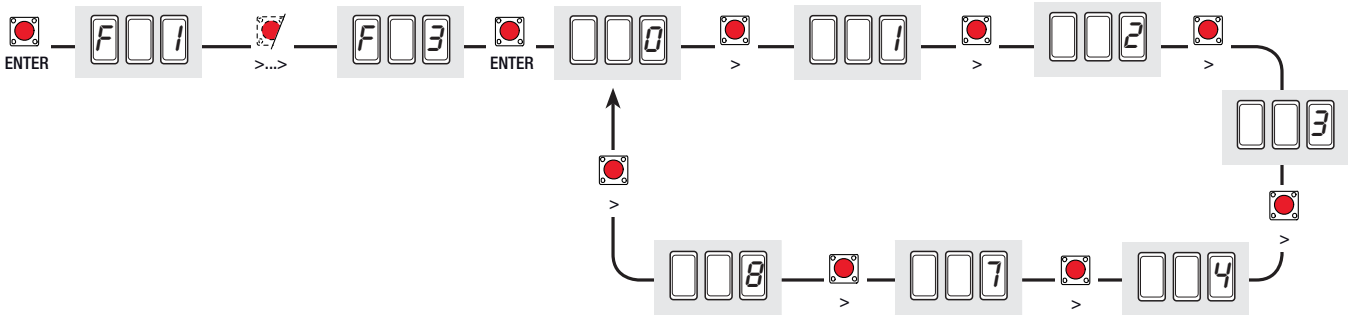

F5 (Safety Test): allows the card to check the efficiency of any safety devices (i.e. photocells) after every opening or closing command.

0 = Deactivated (*default setting*); 1 = CX; 2 = CY; 3 = CX+CY

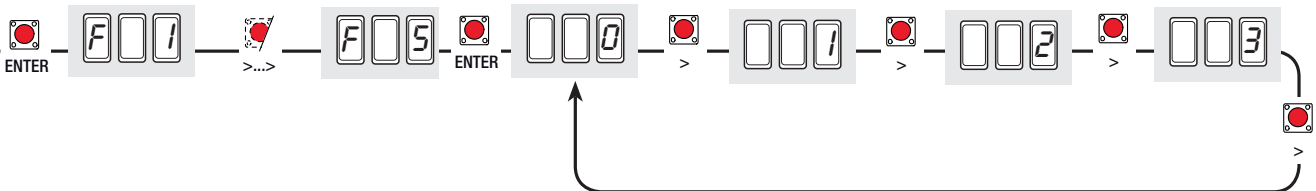

F6 (Maintained action): the gate works by keeping the button pressed (button 2-3 for opening, button 2-4 for closing, or if set to the "Closing" function, only with button 2-4. (This excludes all other command devices including radio commands).

0 = Deactivated (*default setting*); 1 = Activated.

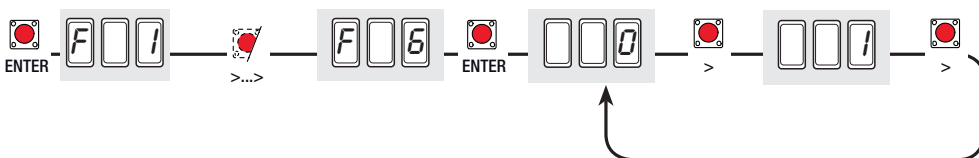

F7 (2-7Command): setting the contact on 2-7 to step-by-step (open-close) or sequential (open-stop-close-stop).

0 = step-by-step (*default setting*); 1 = sequential.

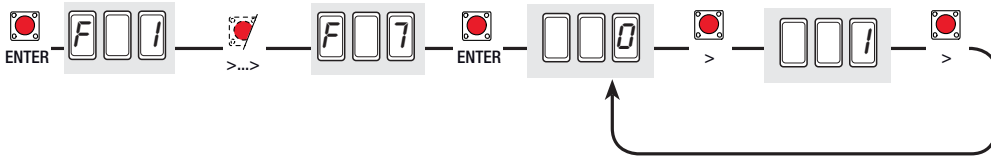

F8 (2-3P Command): setting the 2-3P contact to pedestrian opening (second gate leaf opens fully) or partial (second gate leaf opens partially depending on the time setting of the percentage between 10 and 80 of the gate run, function "F36").

0 = pedestrian opening (*default setting*); 1 = partial setting.

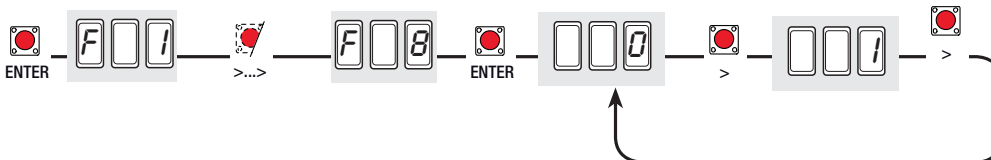

F9 (Obstacle detection): when motor is stopped (gate closed or after a total stop command) it prevents any movement if safety devices, such as photocells, detect any obstacles.

0 = Deactivated (*default setting*); 1 = Activated.

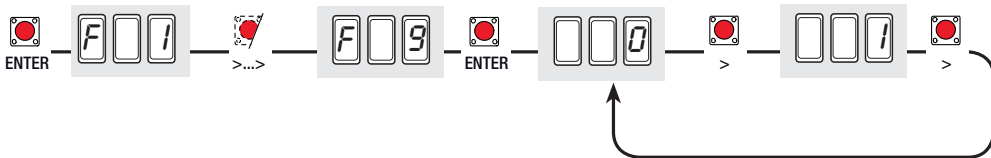

F10 (Opening Warning light): light bulb connected on 10-5, warns of gate status.

0 = gate open and moving, stays on (*default setting*) 1 = - gate opening, flashes on and off every half second;
 - gate closing, flashes on and off every second;
 - gate open, stays on;
 - gate closed, stays off.

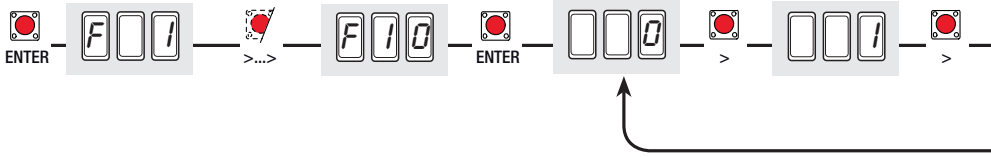

F11 (Exclude Encoder): excludes encoder from managing slow-downs, obstacle detection and sensitivity.

0 = Encoder activated (*default setting*); 1 = Encoder deactivated.

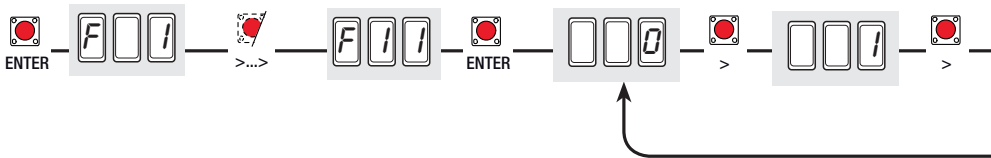

F12 (Slowed-down thrust): at each opening or closing command, the gate leaves move slower for a few seconds.

0 = Deactivated (*default setting*), 1 = Activated.

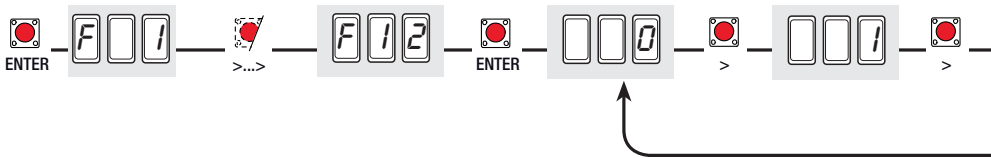

F 13 (closing thrust): at the closing endpoint, the gearmotors give the gate leaves a brief final-closing thrust.
 0 = Deactivate (*default setting*); 1 = 1. = Minimum thrust 2. = Medium thrust 3. = Maximum thrust

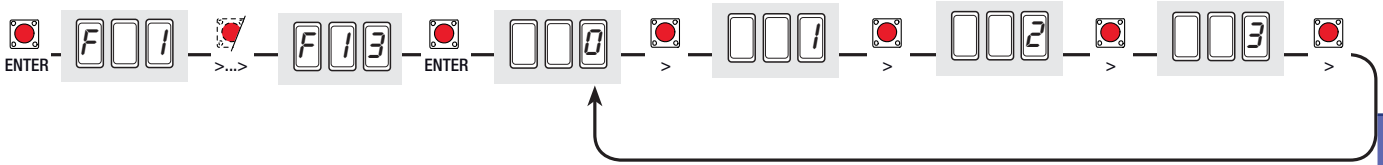

F 14 (Type of sensor): setting the type of sensor for the operator command via (TSP00) transponder or (LT001) magnetic card reader with R700 encoder card or S7000 keyboard with R800 encoder card.

0 = TAG; 1 = S7000 (*default setting*).

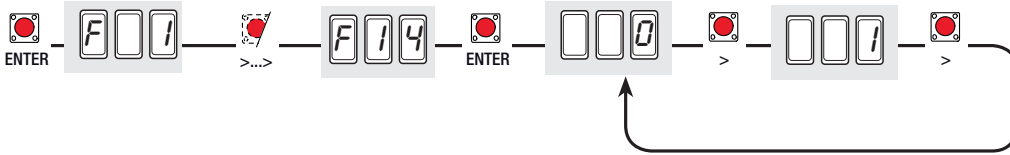

F 16 (Ram head blow): before any opening run, the gate leaves will press onto the mechanical endstop for a few seconds, to help release the electro-lock (to set the time, see “F26”).

Note: this function is only visible for the Myto, Frog.J, Stylo-RME and Amico gearmotors.

0 = Deactivate (*default setting*); 1 = Activate.

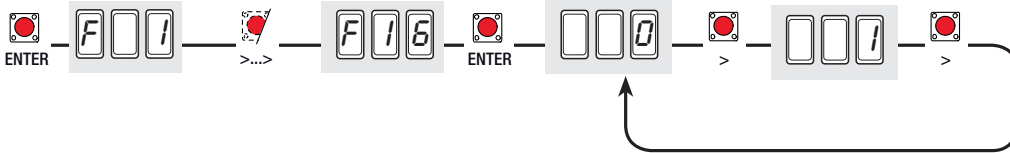

F 17 (Lock): releasing the electrolock while closing and opening (for time setting see “F27” function).

Note: Myto, Frog.J, Stylo-RME and Amico gearmotors.

0 = with opening command (*default setting*); 1 = with closing command; 2 = with both commands.

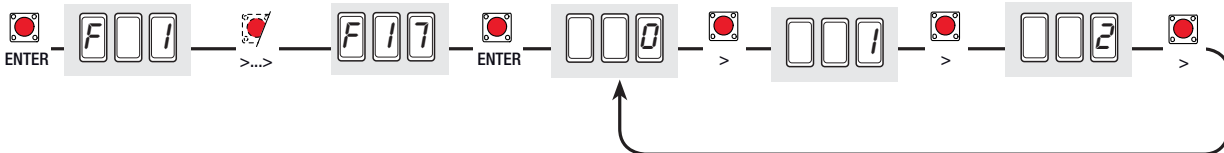

F 18 (10-E Light): output on contact 10-E for light with following function:

- movement flashing, flashes during gate opening and closing.
- outdoor lamp that can be freely positioned, for additional lighting of the driveway – is set up as a courtesy light and stays on for an adjustable time interval (see function “F25”) or as a cycle light, which stays on from the moment the gate leaf begins to open, until it is fully closed (including automatic closing time).

0 = Flashing light (*default setting*); 1 = Cycle; 2 = Courtesy.

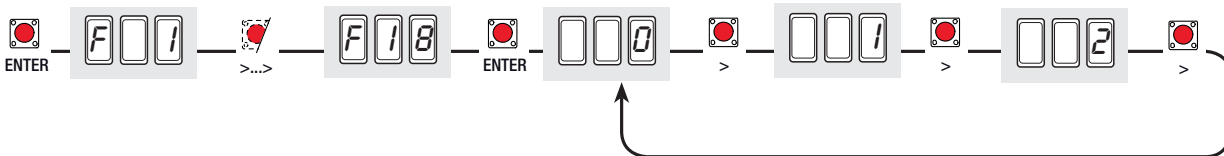

F 19 (Automatic Closing time): The automatic closing timer activates at each opening endpoint. The predetermined time may be adjusted, and is in any case dependent on any safety devices that may activate; and it does not activate after a total safety “stop” or during a power outage.

The waiting time can be deactivated or set to between 1” and 180”.

0 = Deactivated (*default setting*); 1 = 1 second; 2 = 2 seconds; 180 = 180 seconds.

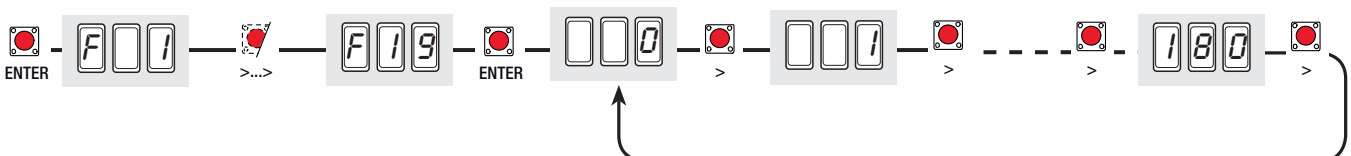

F20 (Automatic closing time after partial or pedestrian opening): Automatic closing time of the gate leaf after a partial opening or pedestrian command. Once this time has elapsed, the gate automatically closes and it is in any case conditioned by any safety devices that may be triggered, and is deactivated after a total safety "stop" or due to a power failure.

The waiting time can be deactivated or set to between 1" and 180".
 Note: the automatic closing time (see F 19) must not be deactivated.

1 = 1 second; 2 = 2 seconds; 5 = 5 seconds (default setting); 180 = 180 seconds.

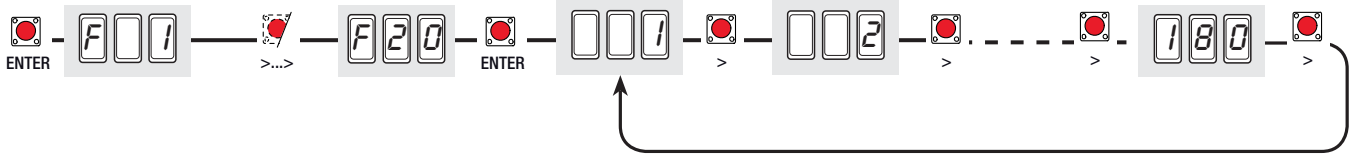

F21 (Pre-flashing time): after an opening or closing command, the flashing light, connected to 10-E, starts flashing for a preset time interval before starting the gate run.

The pre-flashing time can be deactivated or set to between 1" and 10".

0 = deactivated (default setting); 1 = 1 second; 2 = 2 seconds; 10 = 10 seconds.

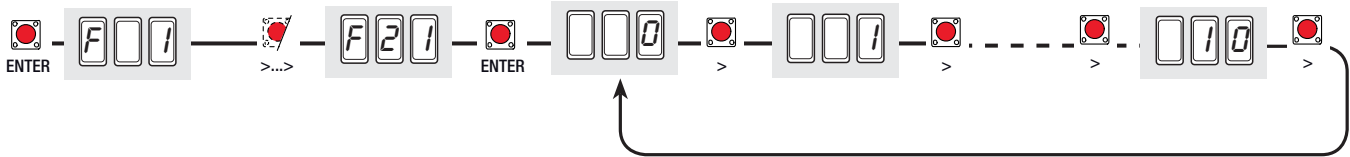

F22 (Working time): working time of the motors when opening or closing.

The working time may be set to between 5" and 120".

5 = 5 seconds; 120 = 120 seconds; (default setting).

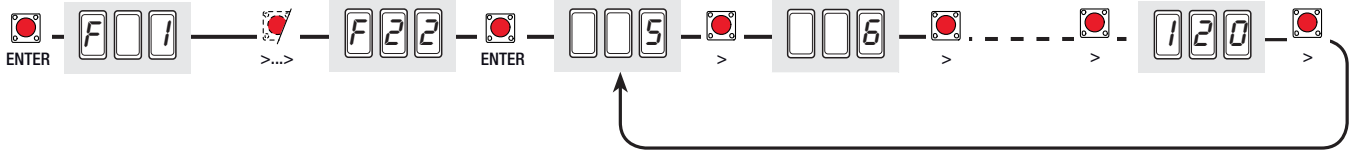

F23 (Opening slow-down time): after an opening command, the gate leaf of the M1 gearmotor delays opening compared to the M2 gearmotor for an adjustable time interval.

The delay time can be deactivated or set to between 1" and 10".

0 = deactivated (default setting); 1 = 1 second; 2 = 2 seconds; 10 = 10 seconds.

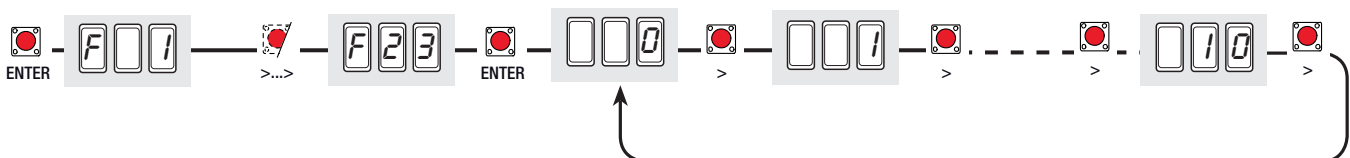

F24 (Closing slow-down time): after a closing command, the gate leaf of the M2 gearmotor delays closing compared to the M1 gearmotor for an adjustable time interval.

The delay time can be deactivated or set to between 1" and 25".

0 = deactivated (default setting); 1 = 1 second; 2 = 2 seconds; 25 = 25 seconds.

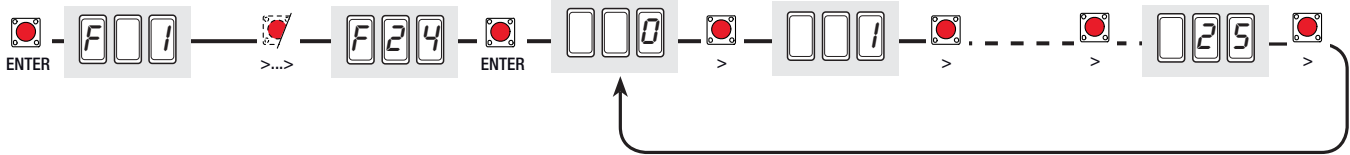

F 25 (Courtesy light time) : supplementary light connected on (10-E), stays on while gate is opening and closing.
The time can be set to between 60" and 180".

60 = 60 seconds (default setting); 61 = 61 seconds; 180 = 180 seconds.

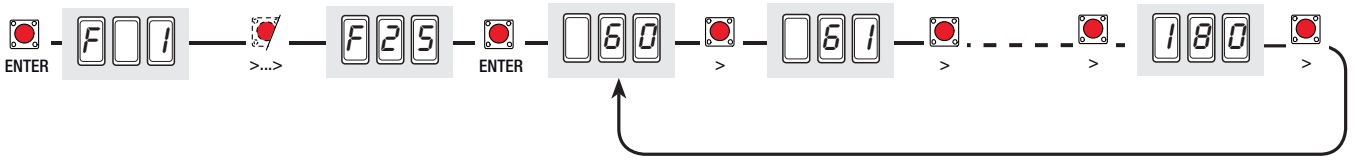

F 26 (Ram head blow) : thrust time of the gearmotor when in final closing and opening stage after each command.
The time may be set to between 1" and 2".

Note: this function only appears for the Myto, Frog-J, Stylo-RME and Amico gearmotors.

1 = 1 second (default setting); 2 = 2 seconds.

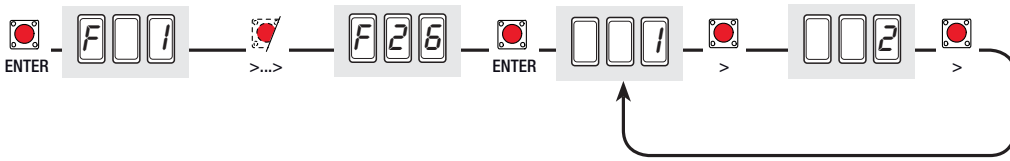

F 27 (lock time) : action time for releasing the electrolock with each opening or closing command (see F 17).
The time can be set to between 1" and 4".

Note: this function only appears for the Myto, Frog-J, Stylo-RME and Amico gearmotors.

1 = 1 second (default setting); 4 = 4 seconds.

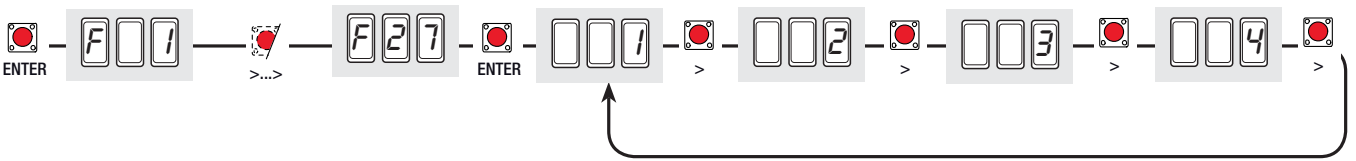

F 28 (M1 motor speed) : setting the speed of operation of the M1 motor calculated as a percentage:

40 = 40% of the motor speed(minimum); 100 = 100% of the motor speed (maximum and default setting).

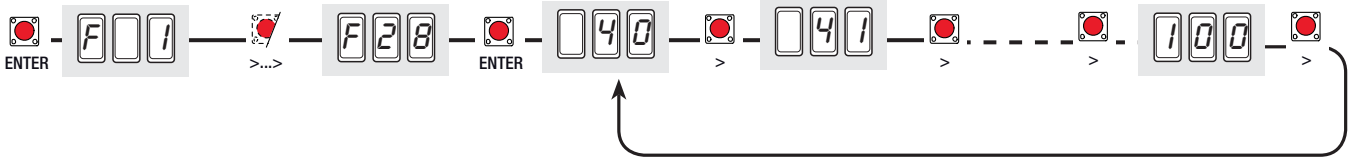

F 29 (M2 motor speed) : setting the speed of operation of the M2 motor calculated as a percentage:

40 = 40% of the motor speed(minimum); 100 = 100% of the motor speed (maximum and default setting).

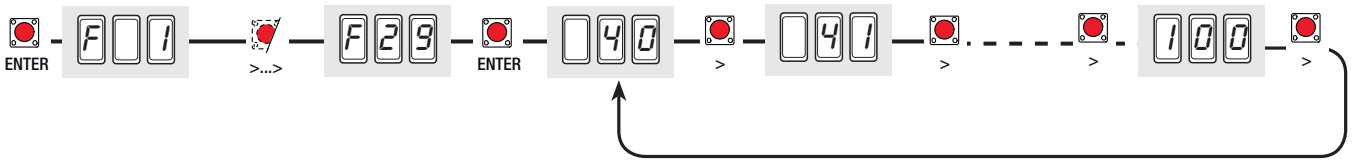

F 30 (Slow-down speed of M1 motor) : setting the speed of the M1 motor during slow downs, calculated as a percentage.

20 = 20% motor slow-down speed (minimum); 50 = 50% motor slow-down speed (default setting);
..... 60 = 60% motor slow-down speed (maximum).

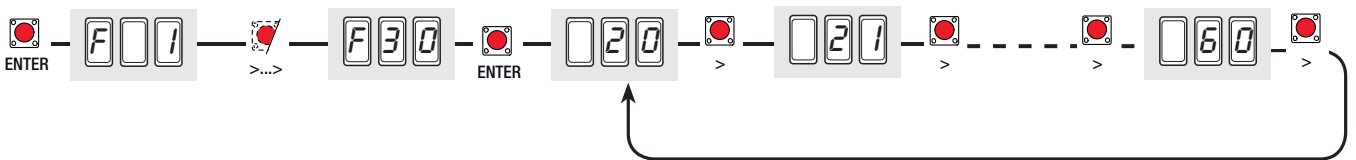

F 31 (Slow-down speed of M2 motor) : setting the speed of the M2 motor during slow downs, calculated as a percentage.

20 = 20% motor slow-down speed (minimum); 50 = 50% motor slow-down speed (*default setting*);
 60 = 60% motor slow-down speed (maximum).

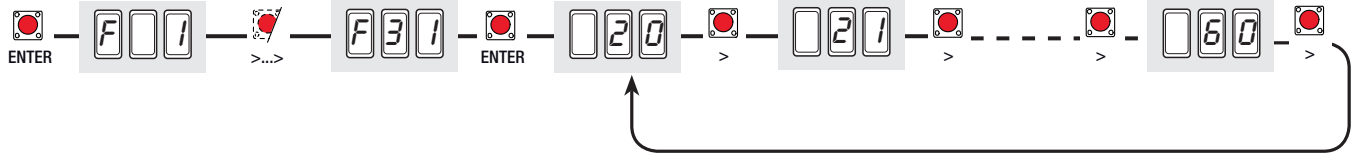

F 32 (Additional slow-down when closing of M1 + M2) : Setting of an additional reduction in speed during closing slow-downs for the straight-arm M1 and M2 motors; the reduced speed is calculated as a percentage.

Note: this function only appears for the Myto, and Stylo straight-arm gearmotors.

10 = 10% motor slow-down speed (minimum); 50 = 50% motor slow-down speed (*maximum and default setting*)

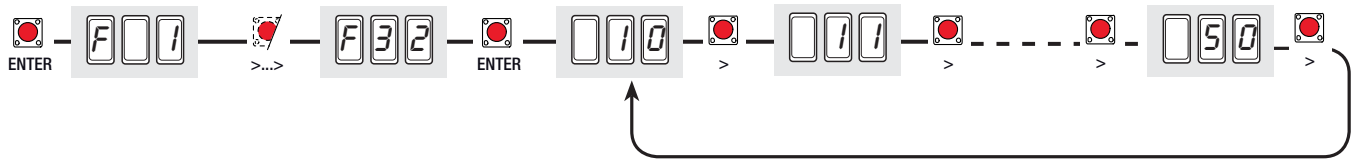

F 33 (calibration speed) : setting the speed only for the gate calibration phase, calculated as a percentage.

30 = 30% of the motor speed; 50 = 50% of the motor speed (*default setting*); 60 = 60% of the motor speed.

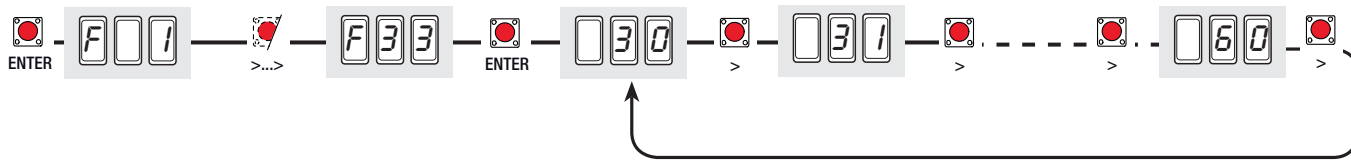

F 34 (gate run sensitivity) : adjusts the obstacle detection sensitivity during the gate runs.

10 = maximum sensitivity; 100 = minimum sensitivity (*default sensitivity*).

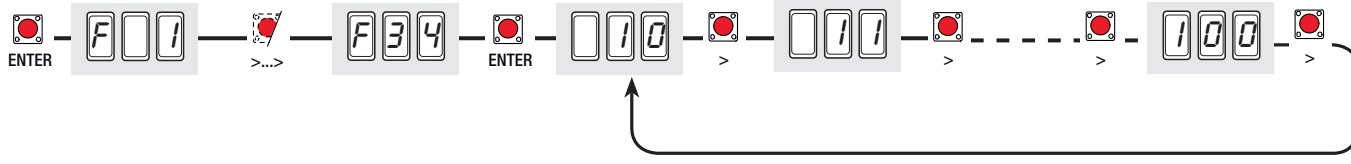

F 35 (Slow-down sensitivity) : adjusts the obstacle detection sensitivity during slow-downs.

10 = maximum sensitivity; 100 = minimum sensitivity (*default sensitivity*).

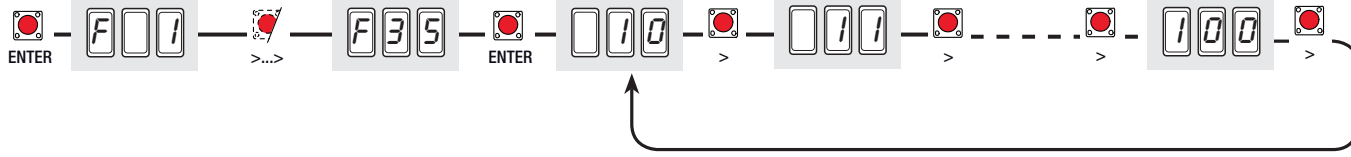

F 36 (Adjusting Partial Opening) : adjusts the opening of the gate leaf of the M2 (second) motor as a percentage of the total gate run.

10 = 10% of the gate run (*default setting*); 80 = 80% of the gate run.

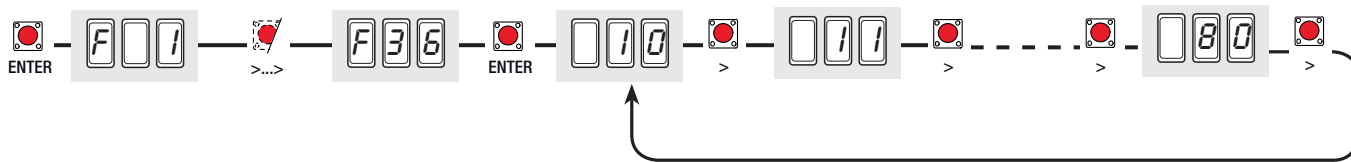

F 37 (Slow-down point when opening the M1 motor) : adjusts the point at which the M1 motor begins to slow down when opening. The beginning slow-down point is calculated as a percentage of the full gate run (see paragraph illustrating the slow-down areas and points)

10 = 10% of the gate run; 25 = 25% of the gate run (*default setting*); 60 = 60% of the gate run.

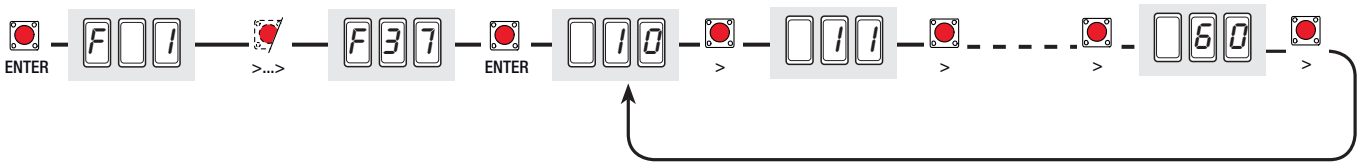

F 38 (Slow-down point when closing the M1 motor) : adjusts the point at which the M1 motor begins to slow down when closing. The beginning slow-down point is calculated as a percentage of the full gate run (see paragraph illustrating the slow-down areas and points)

10 = 10% of the gate run; 25 = 25% of the gate run (*default setting*); 60 = 60% of the gate run.

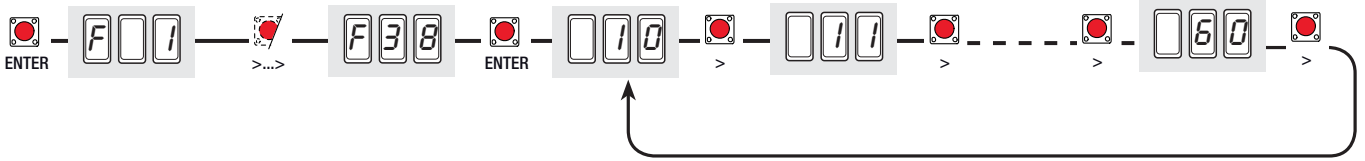

F 39 (Point when M1 motor draws fully open) : adjusts the point at which the M1 motor begins drawing to the fully-open position. This point is calculated as a percentage of the full gate run (see paragraph illustrating the slow-down areas and points)

1 = 1% of the gate run; 5 = 5% of the gate run (*default setting*); 10 = 10% of the gate run.

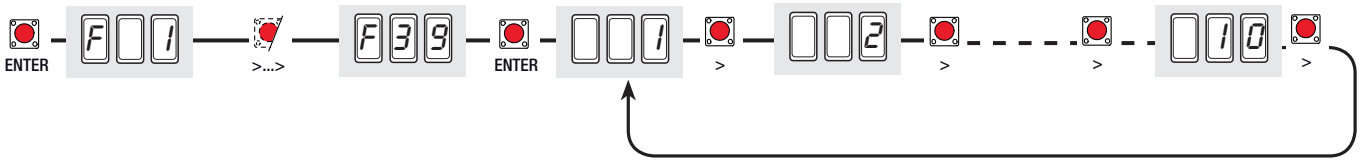

F 40 (Point when M1 motor draws fully closed) : adjusts the point at which the M1 motor begins drawing to the fully-closed position. This point is calculated as a percentage of the full gate run (see paragraph illustrating the slow-down areas and points at which gate draws fully open or closed.)

1 = 1% of the gate run; 5 = 5% of the gate run (*default setting*); 10 = 10% of the gate run.

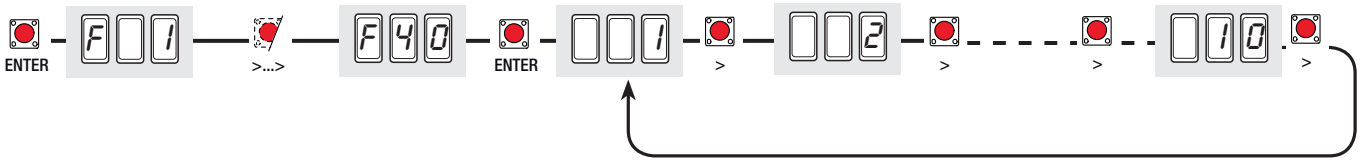

F 41 (Point when M2 motor is fully open) : adjusts the point at which the M2 motor begins to be fully-open.

The beginning slow-down point is calculated as a percentage of the full gate run (see paragraph illustrating the slow-down areas and points at which gate draws fully open or closed)

10 = 10% of the gate run; 25 = 25% of the gate run (*default setting*); 60 = 60% of the gate run.

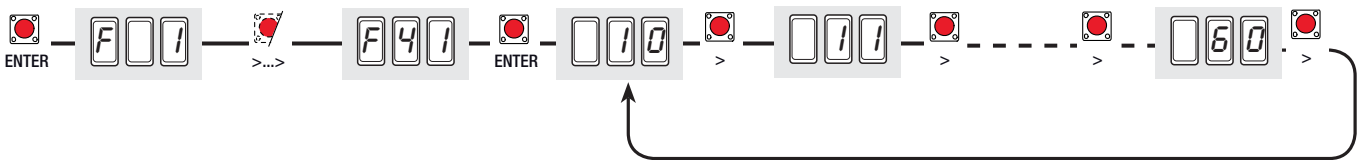

F 42 (Slow-down point when closing the M2 motor) : adjusts the point at which the M2 motor begins to slow down when closing. The beginning slow-down point is calculated as a percentage of the full gate run (see paragraph illustrating the slow-down areas and points at which gate draws fully open or closed)

10 = 10% of the gate run; 25 = 25% of the gate run (*default setting*); 60 = 60% of the gate run.

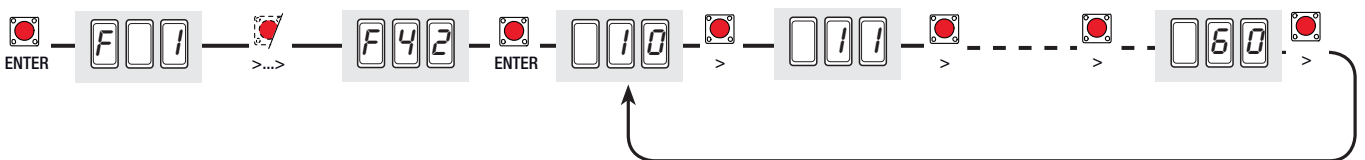

F 43 (Point when M2 motor draws fully open) : adjusts the point at which the M2 motor begins drawing to the fully-open position. This point is calculated as a percentage of the full gate run (see paragraph illustrating the slow-down areas and points at which gate draws fully open or closed)

1 = 1% of the gate run; 5 = 5% of the gate run (default setting); 10 = 10% of the gate run.

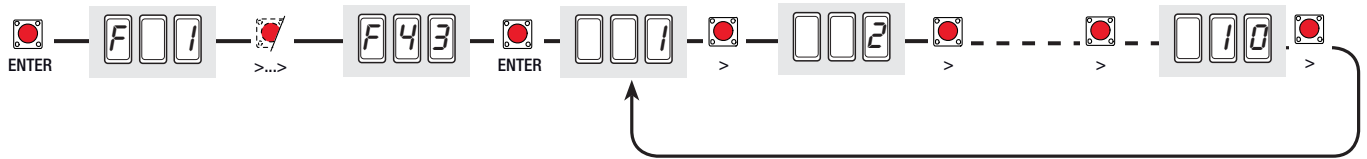

F 44 (Point when M2 motor draws fully closed) : adjusts the point at which the M2 motor begins drawing to the fully-closed position. This point is calculated as a percentage of the full gate run (see paragraph illustrating the slow-down areas and points)

1 = 1% of the gate run; 5 = 5% of the gate run (default setting); 10 = 10% of the gate run.

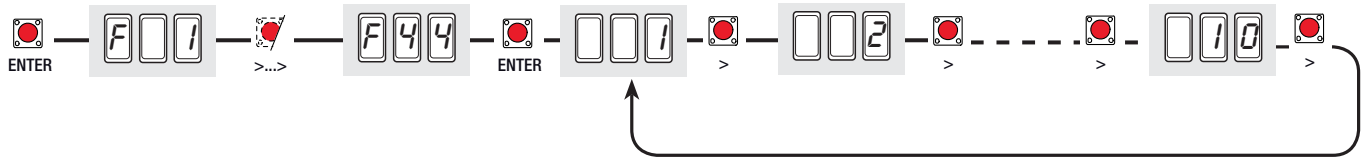

F45 (Additional dosing slow-down point) : adjusts the point at which there is an additional slow-down when closing, calculated as a percentage of the slow-down.

Note: this function is visible only for the straight-arm Myto and Stylo gearmotors.

10 = 10% of the slow-down run; 50 = 50% of the slow-down run (default setting); 100 = 100% of the slow-down run.

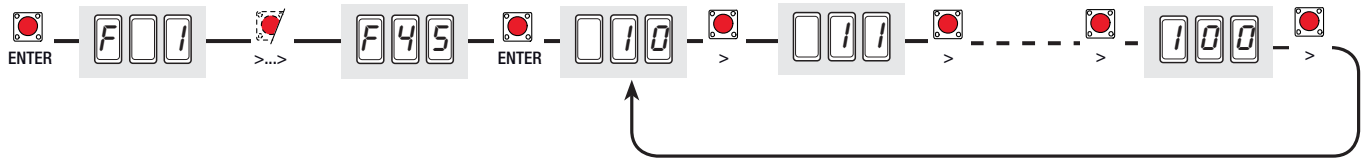

F 46 (Number of Motors) : sets the number of motors connected to the control panel.

0 = Engages both the M1 and M2 motors (default setting); 1 = Engages only one, the M2 motor.

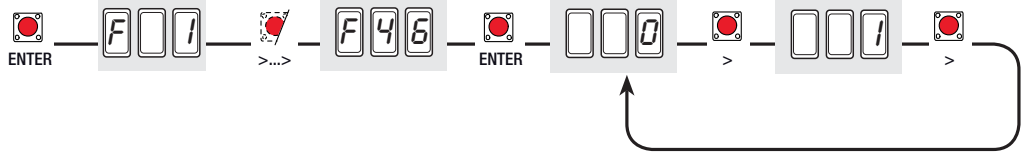

F 50 (Save data) : saves all users and settings in the memory roll.

Note: this function appears only if the memory roll is inserted into the mother board.

0 = Deactivated; 1 = Activated

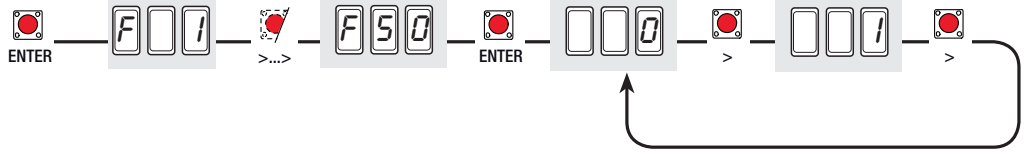

F 51 (Data Read out) : loads the data from the memory roll into the mother board.

Note: this function appears only if the memory roll is inserted into the mother board.

0 = Deactivated; 1 = Activated.

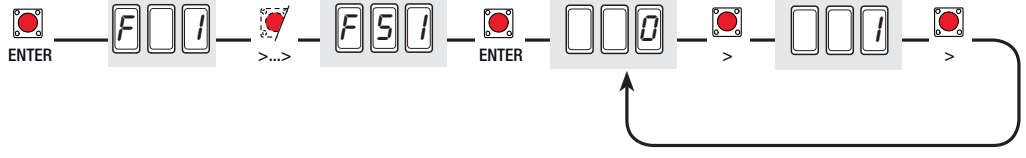

U 1 (add user with assigned command) : add user (max. 25 users) assigned to a command via transmitter or other device (see paragraph on adding users with assigned command).

1 = step-by-step command (open-close); 2 = sequential command (open-stop-close-stop); 3 = open only command; 4 = pedestrian / partial opening command (see function "F8"; 5 = B1-B2 contact output.

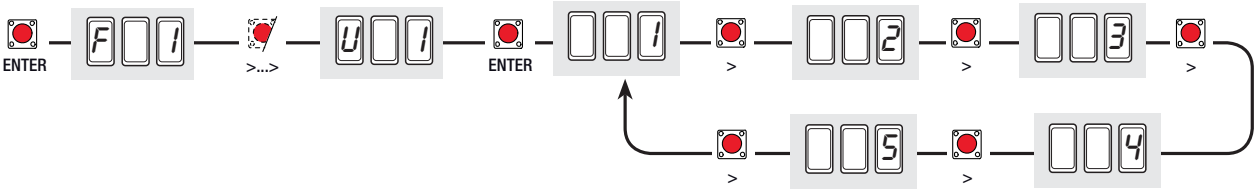

U 2 (Cancel user) : cancels single user (see paragraph on cancelling single users)

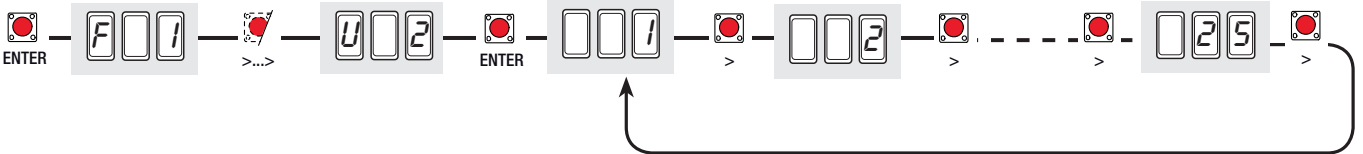

U 3 (Cancel users) : cancels all memorized users. Press ENTER to confirm.

0 = Deactivated; 1 = Cancel all users.

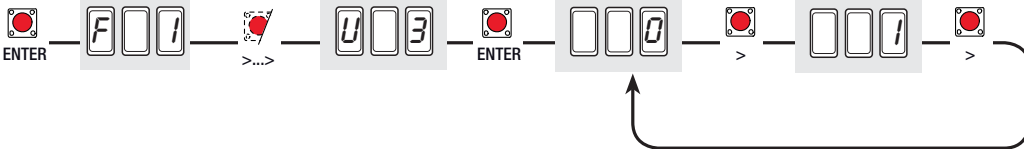

Info Menu

H 1 (Version) : displays software version.

Decoding cards

To insert, change, remove users or to command the operator via radio command, insert the AF43S card.
 If using the transponder or card reader, insert the R700 card or, alternatively, the R800 card for the keyboard selector.
 Insert the memory roll to save and load all settings including users registered by another card.

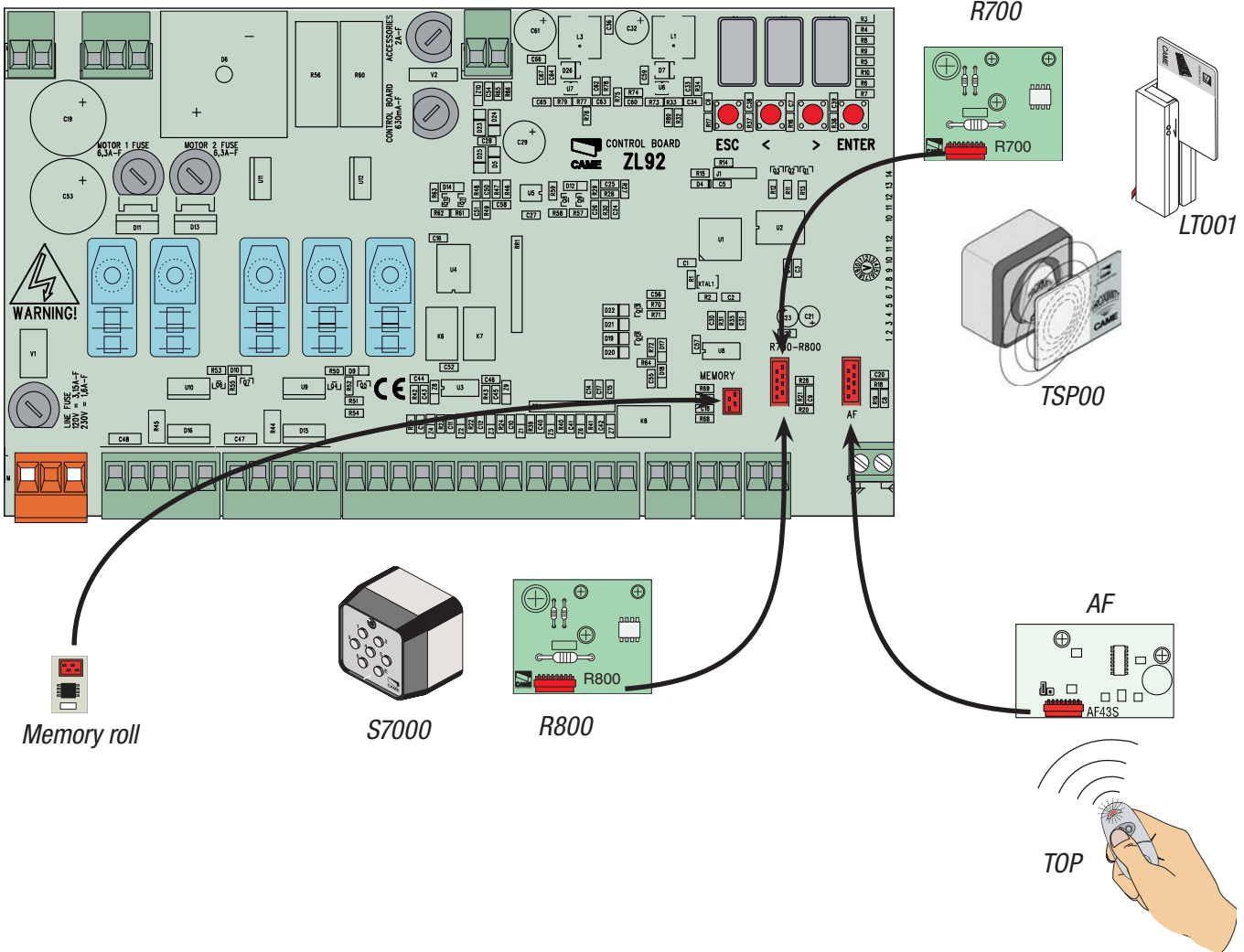

Frequency/MHz	Card	Transmitter
FM 26.995	AF130	TFM
FM 30.900	AF150	TFM
AM 26.995	AF26	TOP
AM 30.900	AF30	TOP
AM 433.92	AF43S	TAM / TOP ATOMO / TWIN
AM 433.92	AF43TW	TWIN
AM 40.685	AF40	TOUCH
AM 868.35	AF868	TOP

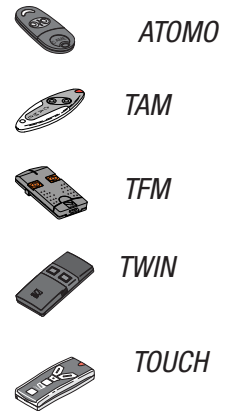

Adding users with an assigned command

N.B.: Before proceeding, remove the memory roll card.

- 1) Select "U 1".
Press ENTER to confirm.

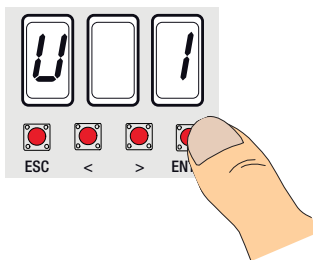

- 2) select command (1=step-by-step, 2=sequential, 3=open, 4=pedestrian / partial opening, 5= B1-B2 output contact) to assign to user via the greater-than and lesser-than arrows on the keyboard...

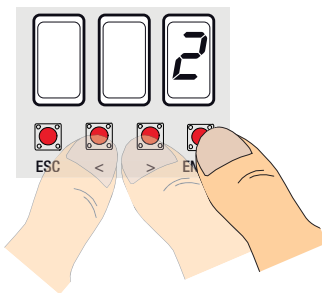

- 3) ...an available number between 1 and 25 will flash for a few seconds. This number will be assigned to the user after sending the code via transmitter or other command device.

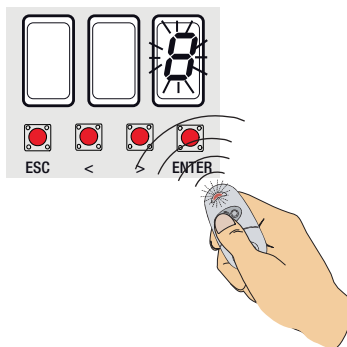

Assigned	Command user
1 -	
2 -	
3 -	
4 -	
5 -	
6 -	
7 -	
8 -	
9 -	
10 -	
11 -	
12 -	
13 -	
14 -	
15 -	
16 -	
17 -	
18 -	
19 -	
20 -	
21 -	
22 -	
23 -	
24 -	
25 -	

Cancelling single users

- 1) Select "U 2".
Press ENTER to confirm.

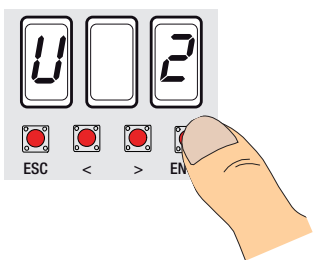

- 2) Select the number of the user to cancel using the greater-than/lesser-than arrow keys.
Press ENTER to confirm...

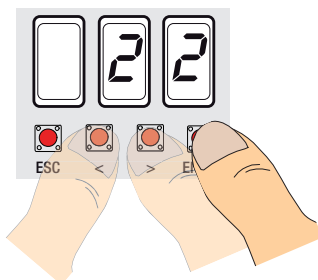

- 3) ..."CLr" will be displayed to confirm the cancellation.

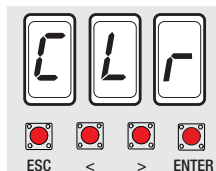

Motor tests

1) Select "A2".
Press ENTER to confirm.

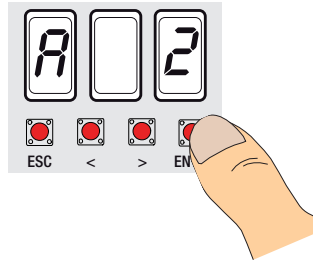

2) Select 1 to activate test.
Press ENTER to confirm...

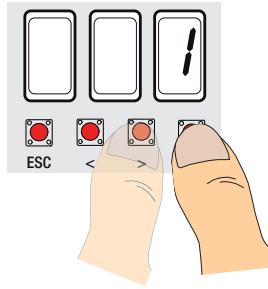

3) ... "---" will be displayed, standing by for a command...

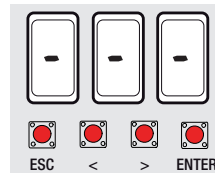

4) Keep the ">" key pressed down and check that the gate leaf of the second gearmotor (M2) opens fully.

Note: if the gate leaf closes instead of opening, invert the motor phases (M2 with N2).

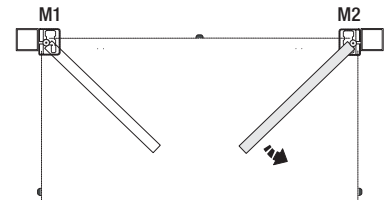
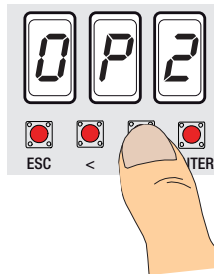

5) Carry out the same procedure with the "<" key to check the gate leaf of gearmotor (M1).

Note: if the gate leaf closes fully, invert the motor phases (M1 with N1).

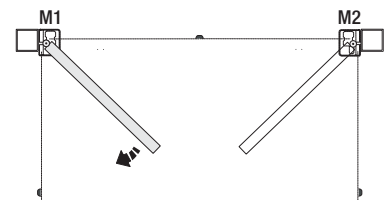
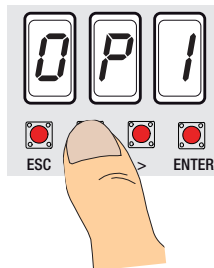

N.B: before proceeding with the calibration of the gate run, check that the area of movement is free of any obstacles and check that there is a mechanical stop or both opening and closing.

Important! While calibrating, all safety devices will be disabled until the end of the calibration excluding the “total stop”

- 1) Select “A3”.
Press ENTER to confirm.

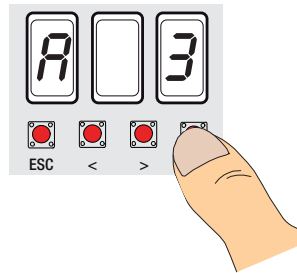

- 2) Select 1 and press ENTER to confirm, the automatic gate run calibration procedure...

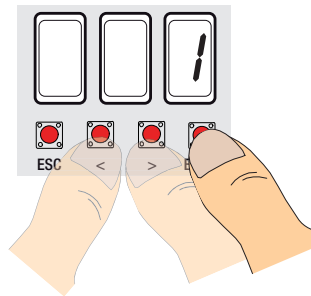

- 3) the gate leaf of the first motor will close fully until the mechanical stop...

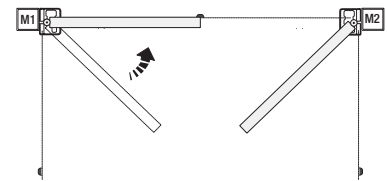
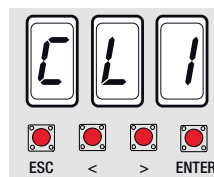

- 4) ...then, the gate leaf of the second motor will do the same...

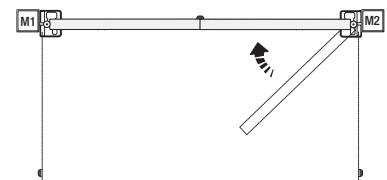
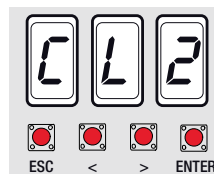

- 5) ...then, the gate leaf of the second motor, shall fully open until the mechanical stop...

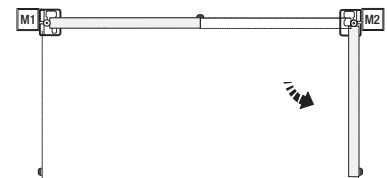
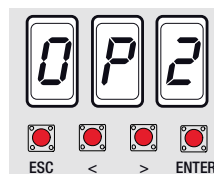

- 6) ...then, the gate leaf of the first motor will do the same.

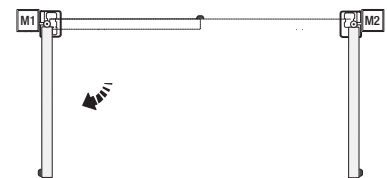
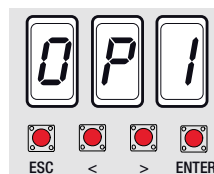
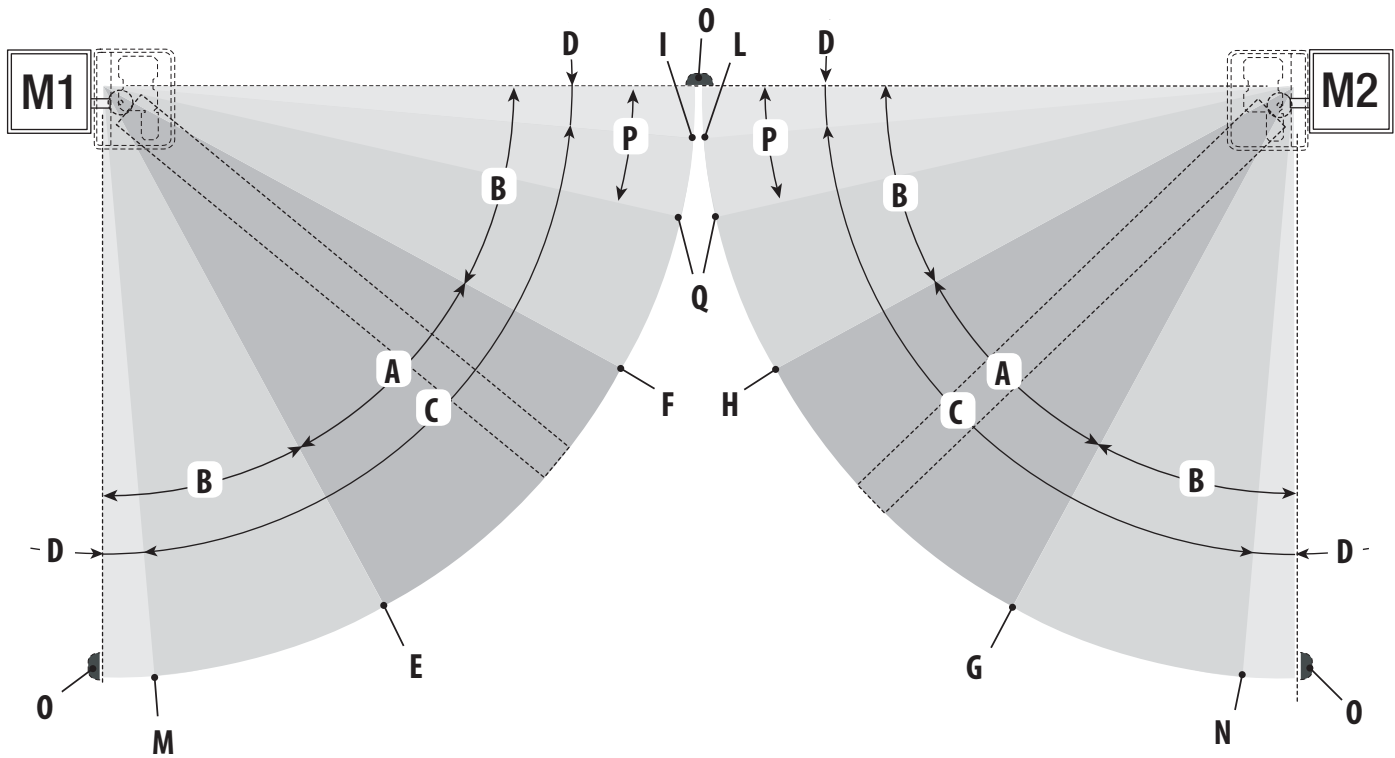

Illustration of the slow-down areas and points at which gate draws to the fully open or closed position

Note: the slow-down areas and points at which the gate draws to the fully open or closed position are tested according to the parameters set forth by Technical Norms EN12445 and EN12453 regarding compatibility of impact forces generated by moving gate leaves.



A = Area of movement at normal speed

B* = Run zone at slow-down speed

C = Encoder intervention zone with movement inversion

D = Encoder intervention zone with movement stop

E = Opening slow-down beginning point (M1 Open Slow- %)

F = Closing slow-down beginning point (M1 Close Slow- %)

G = Opening slow-down beginning point (M2 Open Slow- %)

H = Closing slow-down beginning point (M2 Close Slow- %)

I** = Point at which gate begins drawing to fully-closed position (M1 Close appr. %)

L** = Point at which gate begins drawing to fully-closed position (M2 Close appr. %)

M** = Point at which gate begins drawing to fully-open position (M1 Acc. AP%)

N** = Point at which gate begins drawing to fully-open position (M2 Acc. AP%)

O = Mechanical Stops

P = Area in which additional slow-down speed takes place when closing, only for the straight-arm Stylo and Myto motors)

Q = Point at which additional slow-down when closing begins, only for the straight-arm Stylo and Myto motors)

* Minimum 600 mm from the Final full stop.

** Set the function's approach % "M1 Close appr." for the first (M1) motor and "M2 Close appr." for the second (M2) motor from the "ENCODER" menu so as to obtain a distance of between 1 and 50 mm max. from the final full stop.

Error messages and warnings

"Er1": M1 motor calibration interrupted; check proper connection and working state of M1 motor.

"Er2": motor calibration interrupted; check proper connection and working state of M1 motor.

"Er3": broken encoder; call for assistance.

"Er4": services test error; check proper connection and working status of the safety devices.

"Er5": insufficient working time;

Check time setting, it could be insufficient to complete the working cycle.

"Er6": maximum number of detected obstacles.

"Er7": transformer overheated, at first opening command, gate leaves stay open.

"C0": contact 1-2 (stop) unused and not deactivated.

"C1/2/3/4/7/8": contacts CX and/or CY are unused and not deactivated.

Red LED indicator light flashes: command card still not calibrated to the gate run.

Phasing out and disposal

 In its premises, CAME cancelli automatici S.p.A. implements an Environmental Management System certified in compliance with the UNI EN ISO 14001 standard to ensure environmental protection.

Please continue our efforts to protect the environment - which CAME considers one of the cardinal elements in the development of its operational and market strategies - simply by observing brief recommendations as regards disposal:

DISPOSAL OF PACKAGING

The packaging components (cardboard, plastic, etc.) are all classifiable as solid urban waste products and may be disposed of easily, keeping in mind recycling possibilities.

Prior to disposal, it is always advisable to check specific regulations in force in the place of installation.

PLEASE DISPOSE OF PROPERLY!

PRODUCT DISPOSAL

Our products are made up of various types of materials. Most of them (aluminium, plastics, iron, electrical wires, etc.) may be disposed of in normal garbage collection bins and can be recycled by disposing of in specific recyclable material collection bins and disposal in authorized centres.

Other components (electrical boards, remote control batteries, etc.), however, may contain polluting substances.

They should therefore be removed and given to qualified service companies for proper disposal.

Prior to disposal, it is always advisable to check specific regulations in force in the place of disposal.

PLEASE DISPOSE OF PROPERLY!

CE compliance certification

Declaration **CE** - CAME cancelli automatici S.p.A. declares that this product conforms to the essential, pertinent requirements provided by directives 2006/95/CE and 2004/108/CE.

An original copy of the declaration of conformity is available on request.



English - Manual code: **319V21EN** Vers. **3** 09/2014 © CAME cancelli automatici S.p.A.
The data and information in this manual are subject to change at any time without prior notice required by CAME Cancelli Automatici S.p.A.

- IT** • Per ogni ulteriore informazione su azienda, prodotti e assistenza nella vostra lingua:
EN • For any further information on company, products and assistance in your language:
FR • Pour toute autre information sur la société, les produits et l'assistance dans votre langue :
DE • Weitere Infos über Unternehmen, Produkte und Kundendienst bei:
ES • Por cualquier información sobre la empresa, los productos y asistencia en su idioma:
NL • Voor meer informatie over het bedrijf, de producten en hulp in uw eigen taal:
PT • Para toda e qualquer informação acerca da empresa, de produtos e assistência técnica, em sua língua:
PL • Wszystkie inne informacje dotyczące firmy, produktów oraz usług i pomocy technicznej w Waszym języku znajdują się na stronie:
RU • Для получения дополнительной информации о компании, продукции и сервисной поддержке на вашем языке:
HU • A vállalatra, termékeire és a műszaki szervizre vonatkozó minden további információért az Ön nyelvén:
HR • Za sve dodatne informacije o poduzeću, proizvodima i tehničkoj podršci:
UK • Для отримання будь-якої іншої інформації про компанію, продукцію та технічну підтримку:



CAMEGROUP

CAME Cancelli Automatici S.p.A.

Via Martiri Della Libertà, 15
31030 **Dosson Di Casier** (TV)

☎ (+39) 0422 4940

☎ (+39) 0422 4941

Assistenza Tecnica/Numero Verde 800 295830